

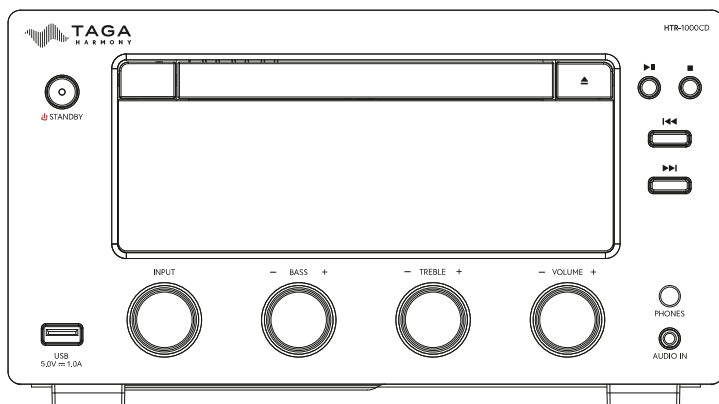

TAGA
HARMONY

HTR-1000CD v.3

HYBRID STEREO CD-RECEIVER



Instruction Manual

Introduction

Thank you for purchasing this TAGA Harmony hybrid CD-Receiver.

TAGA Harmony HTR-1000CD v.3 is a high-fidelity, stereo hybrid FM/DAB+ receiver with a built-in CD player.

Key features:

- Compact size and sleek **aluminum front panel design** is suitable for most interiors.
- **Hybrid design** utilizing two high-performance PSVANE vacuum tubes from the Classic series in the preamp section ensures a very warm, linear and lifelike sound with a high dynamic presentation at the same time.
- **High power - 90W** per channel can properly drive different types of speakers and allows to play music on higher levels without losing on clarity and dynamics.
- **DAB+** (Digital Audio Broadcasting) tuner - your favorite radio stations in the best digital quality. Enjoy your digital radio in high-resolution, crystal clear sound.
- **USB input with charging** - to quickly and easily play music from a USB flash drive (supports AAC-LC, APE, FLAC, MP3, WAV, and WMA files) as well as to charge your mobile devices.
- **Bluetooth®** - to wirelessly stream music from smartphones, tablets or computers.
- **2 analog inputs** including a 3.5mm input on the front to quickly connect external analog audio devices (smartphones, MP3 players etc.).
- **Digital Optical input** - to connect a range of digital audio devices (CD/DVD/Blu-ray player, video game console etc.).
- **Subwoofer output** – to provide extra amount of deep bass by adding an active subwoofer to the system.
- **Headphone output** for those who prefer discrete listening.
- **High-end speaker terminals** accept raw speaker cables up to 10AWG and most popular types of connectors.
- **Variety of sound control functions** - to perfectly adjust the sound to your preferences.
- **Alarm and Sleep Timers** - to take full control of your system.
- Very clear **LCD display**.
- Fully functional **remote controller**.

IEC C8 power inlet and a removable Europlug-IEC C7 power cord an option to upgrade your system with a premium audiophile power cable.

Cleaning

Do not use strong or abrasive cleaners. Use a damp, soft cloth for cleaning.

Specifications and the latest instruction manual edition

Full technical specifications and the latest edition of the instruction manual are available on www.TagHarmony.com.

Contents

Safety Instructions	4
Remote controller	8
Front and Rear Panel	10
Hooking Up Speaker Cables	12
Hooking Up the CD-Receiver	13
Operation	17
ECO-Power/Standby and Automatic Standby features	17
Setting the Clock	18
INPUT selection	18
Sound Control	19
Headphone Connection	21
Dimmer	21
DAB Radio Operation	22
FM Radio Operation	23
CD Player Operation	25
Play from a USB Flash Drive	28
Play via Bluetooth [®]	31
Setting the Sleep Timer	33
Setting the Alarm Timer	33
Additional Information	34
Kit Content	36
Specifications	36

Safety Instructions

IMPORTANT READ THIS SECTION CAREFULLY BEFORE PROCEEDING!



CAUTION

**RISK OF ELECTRIC SHOCK
DO NOT OPEN**



WARNING: TO REDUCE THE RISK OF FIRE OR ELECTRIC SHOCK, DO NOT EXPOSE THIS PRODUCT TO RAIN OR MOISTURE. DO NOT REMOVE COVER (OR BACK). NO USER-SERVICEABLE PARTS INSIDE. REFER SERVICING TO QUALIFIED SERVICE PERSONNEL.



The triangle containing a lightning symbol is intended to alert the user to the presence of uninsulated dangerous voltages within the product's enclosure that may be of sufficient magnitude to constitute a risk of electric shock to persons.



An exclamation mark in a triangle is intended to alert the user to the presence of important operating and maintenance (servicing) instructions in the literature accompanying the appliance.



Class 1 Laser Product

- This unit utilises a laser. Use of controls, adjustments or performance of procedures other than those specified herein may result in hazardous radiation exposure.
- Before moving the unit, ensure the disc tray is empty.
- Always remove the disc when the unit is not in use.
- Failure to do so will risk severely damaging the disc and the unit.
- Do not stack devices, heat from other devices may affect the performance of the unit.

WARNING: TO REDUCE THE RISK OF FIRE OR ELECTRIC SHOCK, DO NOT EXPOSE THIS APPARATUS TO RAIN OR MOISTURE, AND OBJECTS FILLED WITH LIQUIDS, SUCH AS VASES, SHOULD NOT BE PLACED ON THIS APPARATUS.

CAUTION: TO PREVENT ELECTRIC SHOCK, FULLY AND SECURELY INSERT THE POWER CABLE PLUG INTO THE POWER OUTLET, AND POWER CABLE CONNECTOR INTO THE UNIT SOCKET (IF THIS UNIT IS NOT EQUIPPED WITH AN INTEGRATED [ATTACHED] POWER CORD).

CAUTION: FOR CONTINUED PROTECTION AGAINST RISK OF FIRE, REPLACE THE FUSE (IF THE UNIT IS EQUIPPED WITH A USER REPLACEABLE FUSE) ONLY WITH THE SAME AMPERAGE AND VOLTAGE TYPE. IN CASE WHEN THE UNIT IS NOT EQUIPPED WITH A USER REPLACEABLE FUSE - REFER REPLACEMENT TO QUALIFIED SERVICE PERSONNEL.

WARNING: THE UNIT MAY BECOME HOT. ALWAYS PROVIDE ADEQUATE VENTILATION TO ALLOW FOR COOLING. DO NOT PLACE THE UNIT NEAR A HEAT SOURCE, OR IN SPACES THAT CAN RESTRICT VENTILATION.

Safety Instructions

1. Read Instructions - All the safety and operating instructions should be read before the product is operated.
2. Retain Instructions - The safety and operating instructions should be retained for future reference.
3. Heed Warnings - All warnings on the product and in the operating instructions should be adhered to.
4. Follow Instructions - All operating and use instructions should be followed.
5. Cleaning - Unplug this product from the power outlet before cleaning. Do not use liquid cleaners or aerosol cleaners.
6. Water and Moisture - Do not use this product near water - for example, near a bath tub, wash bowl, kitchen sink or laundry tub; in a wet basement; or near a swimming pool; and the like. These precautions also apply to the power cord.
7. Accessories - Do not place this product on an unstable cart, stand, tripod, bracket or table. The product may fall, causing serious injury to a child or adult and serious damage to the product. Use only with a cart, stand, tripod, bracket or table recommended by the manufacturer or sold with the product. Any mounting of the product should follow manufacturer's instructions and should use a mounting accessory recommended by the manufacturer.
8. Ventilation - This unit may be equipped with slots and openings in the cabinet (housing) which are provided for ventilation and to ensure reliable operation of the product and to protect it from overheating and these openings must not be blocked or covered. The openings should never be blocked by placing the product on a bed, sofa, rug or other similar surface. This product should be not placed in a built-in installation such as a bookcase or rack unless proper ventilation is provided or the manufacturer's instructions have been adhered to. For products equipped with a separate power supply unit, leave at least 5cm (2in.) of free space on all sides and the top of the power supply.
9. Power Sources - This product should be operated only from the type of power source indicated on the marking label (placed on the product and/or, if applicable, on a separate power supply unit). If you are not sure of the type of power supply in your home, consult your product dealer or local power company. For products intended to operate from battery power or other sources, refer to the operating instructions.
10. Grounding and Polarity - some units for proper operation or to take full advantage of their capabilities may require to be connected to a grounded power outlet - refer to the user manual for more information.
Some units may have markings for the live (L) and neutral (N) conductors for power - in order to take full advantage of capabilities of such products, it is recommended to properly connect the polarity according to the markings on the unit - refer to the user manual for more information. Connecting the polarity not in accordance with the markings will not affect the durability and reliability of the device.
11. Power-cord Protection - Power supply cords should be routed so that they are not likely to be walked on or pinched by items placed upon or against them, paying particular attention to cords at plugs, convenience receptacles and the point where they exit from the product.
12. Lighting - For added protection for this product during a lighting storm or when it is left unattended and unused for long periods of time, unplug it from the wall outlet and disconnect the antenna or system cables. This will prevent damage to the product due to lighting and power-line surges.
13. Overloading - Do not overload wall outlets, extension cords or integral convenience receptacles as this can result in a risk of fire or electric shock.
14. Object and Liquid Entry - Never push objects of any kind into this product through openings as they may touch dangerous voltage points or short-out parts that could result in a fire or electric shock. Do not expose this apparatus to dripping or splashing and ensure that no objects filled with water, such as vases are placed on the apparatus.
15. Servicing - Do not attempt to service this product yourself as opening or removing covers may expose you to dangerous voltage or other hazards. Refer all servicing to qualified service personnel.
16. Damage Requiring Service - Unplug this product from wall outlet and refer servicing to qualified personnel under the following conditions:
 - when power supply cord or plug is damaged;
 - if liquid has been spilled or objects have fallen into the product;
 - if the product does not operate normally by following the operating instructions. Adjust only those controls that are covered by the operating instructions as an improper adjustment of other controls may result in damage and will require extensive work by a qualified technician to restore the product to its normal operation;
 - if the product has been dropped or damaged in any way;
 - if the product exhibits a distinct change in performance - this indicates a need for a service.
17. Replacement Parts - when replacement parts are required, be sure the technician has used replacement parts specified by the manufacturer or with the same characteristics as the original part. Unauthorized substitutions may result in fire, electric shock or other hazards.
18. Safety Check - Upon completion of any service or repairs to this product, ask the service technician to perform safety check to determine that the products is in proper operating condition.
19. Wall of ceiling mounting - The product should be mounted to a wall or ceiling only as recommended by the manufacturer.
20. Heat - The product should be situated away from heat sources such as radiators, heat registers, stoves or other products (including amplifiers) that produce heat.
21. [Refers to products equipped with vacuum tubes] Tube Cage or cover - For your safety and to protect the vacuum tubes this product may be equipped with the factory installed vacuum tube cage or cover.
It is not recommended to remove the cage or cover unless it is required to change the vacuum tubes.
When the cage or cover is removed - do not touch the vacuum tubes - they may be hot and burn the skin!
22. Operating Environment - Operating environment temperature and humidity of the unit: +5°C to +35°C (+41°F to +95°F); less than 85% RH (cooling slots not blocked).

PACKAGING WARNING

The packaging may contain elements such as plastic, that **should be kept away from small children.**

The thin foil or small elements can stick to the nose and mouth, or may be swallowed and prevent breathing.



Batteries- Safety Instructions

IMPORTANT

READ THIS SECTION CAREFULLY BEFORE PROCEEDING!



Make sure to insert the battery aligning the correct polarity - the positive and negative ends should be facing in the correct direction as marked on equipment.
Incorrect fitting may cause leakage or, in extreme cases, fire or even an explosion.

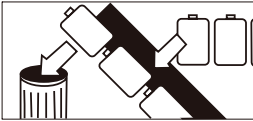

Always replace the whole set of batteries at one time, taking care not to mix old and new batteries or batteries of different types, since this may result in leakage or, in extreme cases, fire or even an explosion.



Store unused batteries in their packaging and away from metal objects which may cause a short-circuit resulting in leakage or, in extreme cases, fire or even an explosion.



Remove dead batteries from equipment and all batteries from equipment when you know you are not going to use for a long time. Otherwise the batteries may leak and cause damage.



Never dispose of batteries in fire as this can cause them to explode. Please recycle dead batteries; do not put with the normal household waste.



Never attempt to recharge ordinary batteries, either in a charger or by applying heat to them. They may leak, cause fire or even explode. There are special rechargeable batteries which are clearly marked as such.



Supervise children if they are replacing batteries by themselves in order to ensure these safety instructions are followed.

Batteries- Safety Instructions



Remember that small button cell batteries such as used in some hearing aids, toys, games and other appliances, may be easily swallowed by young children and this is dangerous.



Keep loose button cells away from young children.



Make sure appliance battery compartments are securely closed.

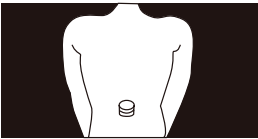

Seek medical assistance if you believe a battery has been swallowed.

Remote Controller



- Always use AAA batteries and do not use the rechargeable batteries.
- If the batteries run out, remove the old batteries and replace them with new ones within several minutes.
- If the batteries are placed incorrectly, they can cause explosion.
- Remove the batteries if the remote controller is not used for a long period of time.
- Do not handle and store the batteries together with metallic tools.
- KEEP AWAY FROM CHILDREN!

Battery Installation

1. Prepare two AAA batteries (provided with this product).
2. Remove the rear battery cover by sliding it downwards.
3. Insert the batteries into the battery compartment. Carefully follow the polarity diagram inside the battery compartment (positive + and negative - symbols).
4. Reinstall the rear cover.

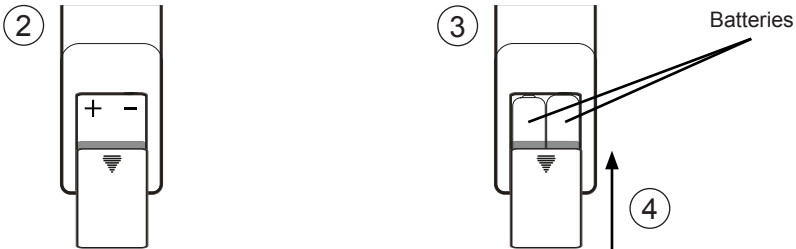

Operating range

Use the remote controller by aiming it at the remote controller sensor. The remote controller can operate in the maximum range of 5 meters away from the CD-Receiver and within 30 degrees from the axis of the controller sensor.

Note! Exposing the remote controller sensor to direct sunlight or strong light may cause faulty operation.

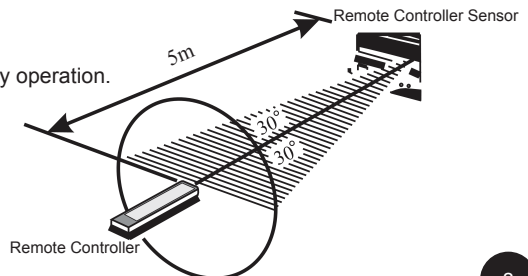

Remote Controller

Note! The remote controller is working with other TAGA Harmony models and some buttons or features are not available (**N/A**) for this CD-Receiver.

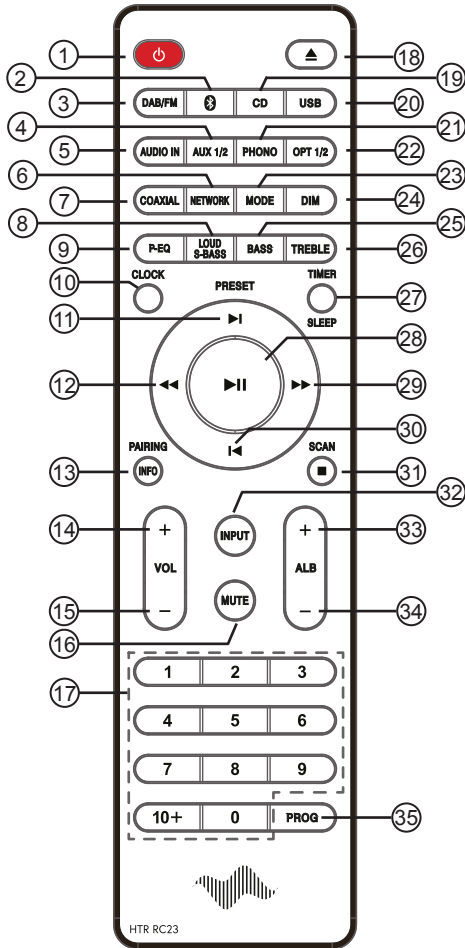

1. Standby Button (⏻)
2. **Bluetooth**® function Button (B)
3. DAB / Tuner function Button (**DAB/FM**)
4. AUX 1,2 function Button (**AUX 1/2**) **AUX 2 N/A**
5. AUDIO IN function Button (**AUDIO IN**)
6. NETWORK function Button (**NETWORK**) **N/A**
7. COAXIAL function Button (**COAXIAL**) **N/A**
8. Loudness Button (**LOUD**)
Super Bass Button (**S-BASS**)
9. Preset Equalizer Button (**P-EQ**)
10. Clock Button (**CLOCK**)
11. Next Button (▶|)
Preset Up Button (**PRESET ▶|**)
12. Long press: Search Backward Button (◀◀)
Tuning Backward Button (◀◀)
13. Pairing Mode Button (**PAIRING**)
Information Button (**INFO**)
RDS Information Button (**INFO**)
14. Volume Up Button (**VOL+**)
15. Volume Down Button (**VOL-**)
16. Mute Button (**MUTE**)
17. Number Buttons (**0-9, 10+**)
18. Open / Close Button (▲)
19. CD function Button (**CD**)
20. USB function Button (**USB**)
21. PHONO function Button (**PHONO**) **N/A**
22. OPTICAL 1,2 function Button (**OPT 1/2**) **OPT 2 N/A**
23. Mode Button (**MODE**)
Stereo / Mono select Button (**MODE**)
24. Dimmer Button (**DIM**)
25. Bass Button (**BASS**)
26. Treble Button (**TREBLE**)
27. Timer / Sleep Button (**TIMER/SLEEP**)
28. Play / Pause Button (▶||)
29. Long press: Search Forward Button (▶▶)
Tuning Forward Button (▶▶)
30. Previous Button (◀|)
Preset Down Button (**PRESET ◀|**)
31. Stop Button (■)
Reset the Network Connection Button (■) **N/A**
SCAN Button (**SCAN**)
32. INPUT selector Button (**INPUT**)
33. Album Up Button (**ALB+**)
34. Album Down Button (**ALB-**)
35. Program Button (**PROG**)
Long press: Auto Scan Button (**PROG**)
Memory Button (**PROG**)

Front and Rear Panel

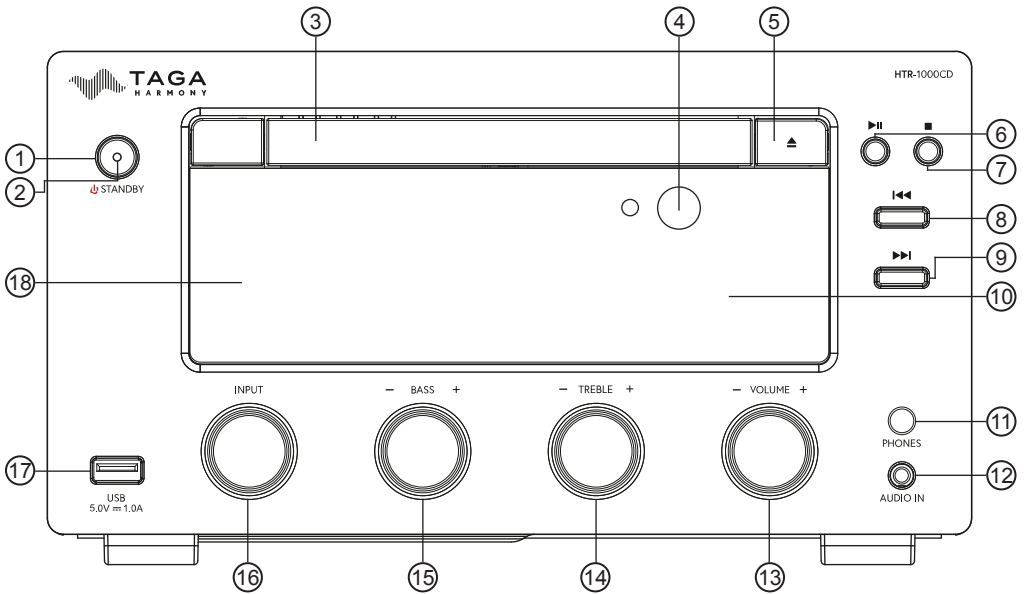

Front Panel:

1. Standby Button (⏻)
2. ECO Power Standby Mode Indicator
3. Disc Tray
4. Remote Controller Sensor
5. Open/Close Button (⏮)
6. Play/Pause Button (⏮⏭)
7. Stop Button (■)
8. Previous Button (⏮⏮)
9. Next Button (⏭⏭)
10. Display
11. Headphone 3.5 mm (1/8') Output
12. AUDIO IN 3.5 mm (1/8') Stereo Input
13. Volume Regulator (- VOLUME +)
14. Treble Regulator (- TREBLE +)
15. Bass Regulator (- BASS +)
16. Input Selector (INPUT)
17. USB Port
18. Vacuum Tube Window

Front and Rear Panel

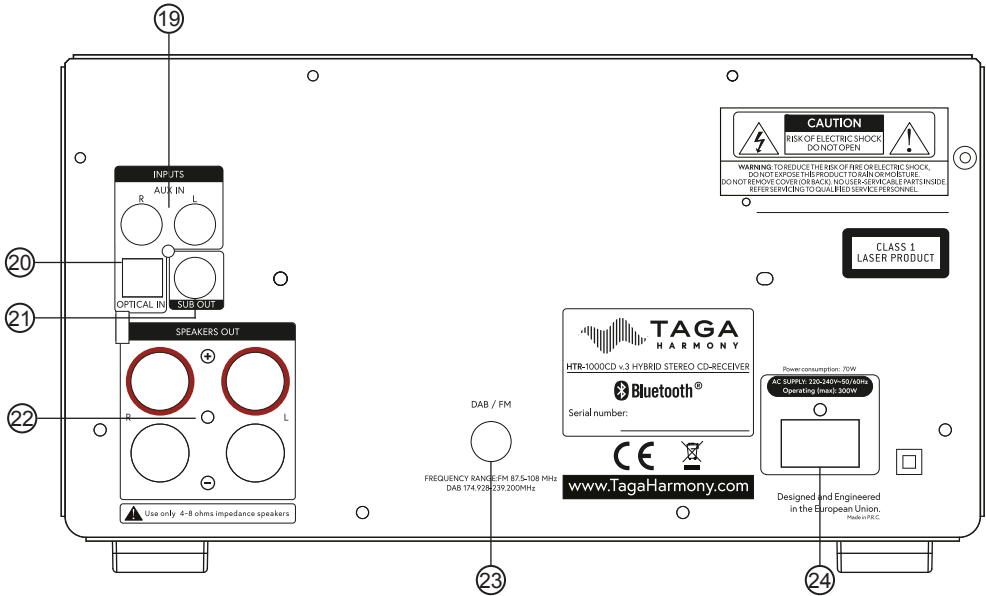

Rear Panel:

19. Analog Stereo RCA Input - **AUX IN**
20. Digital Input - **OPTICAL IN**
21. Subwoofer RCA Output - **SUB OUT**
22. Speaker Connectors: Right and Left Channel Output - **SPEAKERS OUT**
23. DAB/FM Antenna Socket - **DAB / FM**
24. Power Cable Input

Hooking Up Speaker Cables

The Speaker Connectors can accommodate up to 10AWG speaker cables as well as most of popular plugs (banana etc.). It is recommended to leave about 150 cm (5 feet) of extra cable at the amplifier end to facilitate positioning and installation of the amplifier. Do not use staples, nails or other metal objects to secure the cables. You will get the best sound quality and least amount of hum by keeping the cables away from other electrical wires and cables.

Pay attention to connecting the polarity of the amplifier correctly with the speakers in each speaker group (speakers should be connected RED + with RED + amplifier connector, BLACK – with BLACK – amplifier connector).



Before connecting make sure that your amplifier is turned off. Do not let bare speaker wires touch each other or any metal part of this unit it may damage this amplifier and/or speakers. This may void your warranty.

Please refer to your speaker instruction manual for more information.

Connecting speaker cables

Speaker cables have 2 conductors. Each conductor should be connected to a separate speaker connector - mind the polarity while connecting. For each conductor:

1. Remove approximately 10 mm (3/8') of insulation from the end of the conductor. Twist the bare wires firmly together.
2. Loosen the speaker connector.
3. Insert the bare wires of the conductor into the gap of the speaker connector.
4. Tighten the speaker connector.

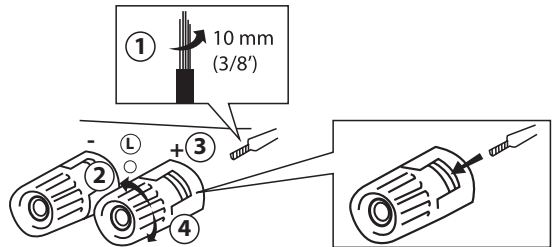

Connecting via banana plug

Mind the polarity while connecting.

Note! An insert hole for the banana plug in some speaker connectors maybe secured with a plastic plug - make sure to remove this plastic plug before inserting the banana plug.

1. Tighten the speaker connector.
2. Insert the banana plug into the end of the corresponding connector.

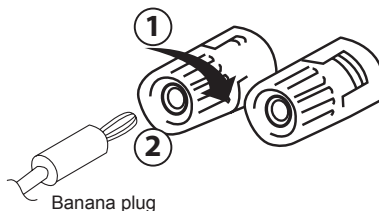

Banana plug

Hooking up the CD-Receiver

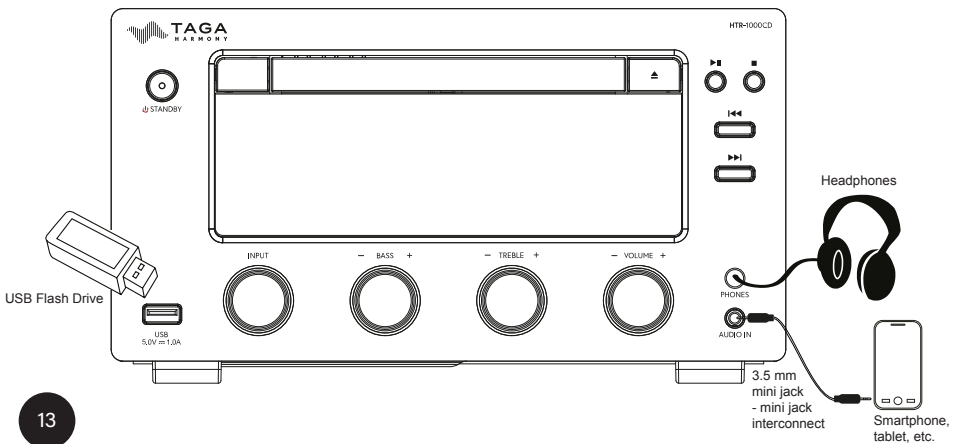
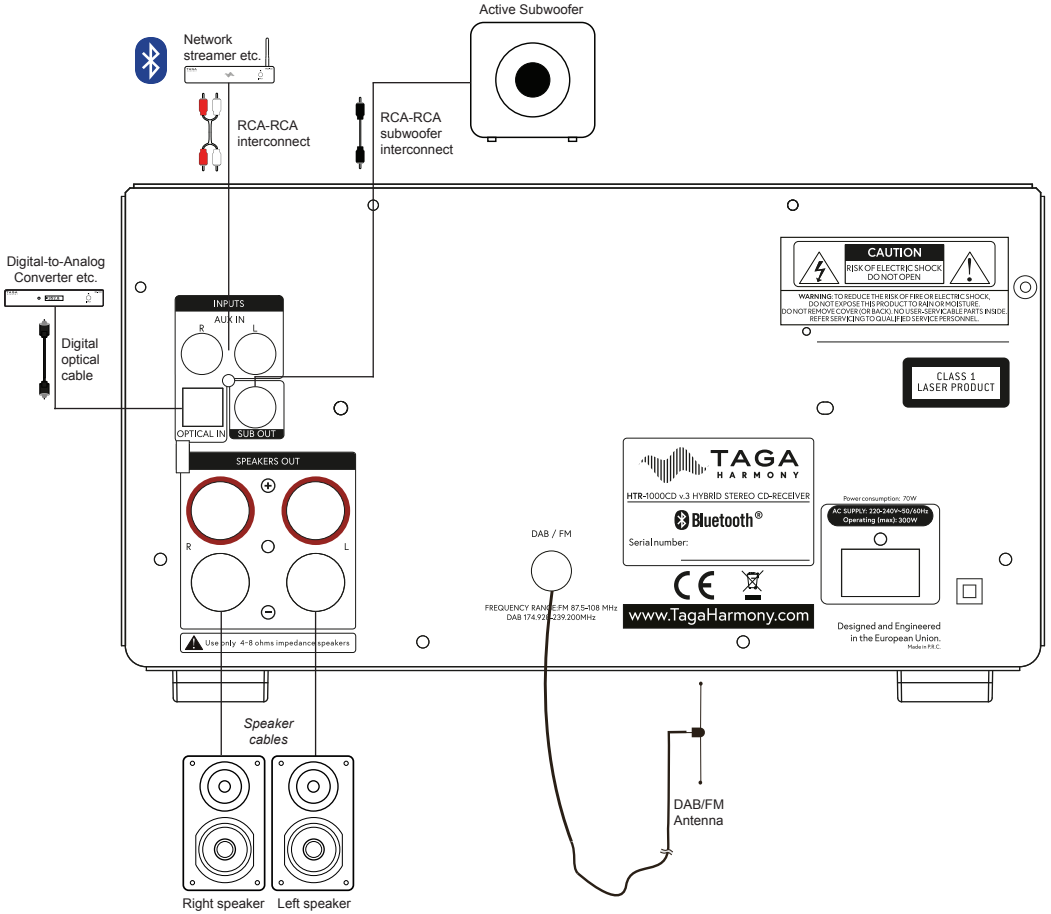

Hooking up the CD-Receiver

Note! Make sure that the Power Cable is disconnected from the CD-Receiver and the wall outlet.

Note! Make sure that external equipment which will be connected to the CD-Receiver is turned off.

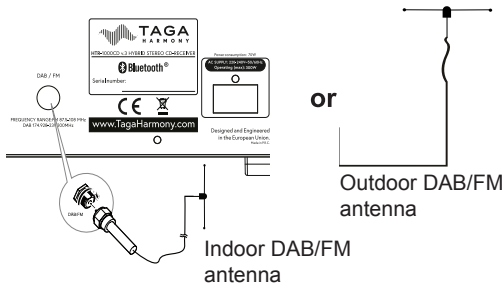

Connecting DAB/FM Antenna

Note! The central pin of the connector in the supplied indoor DAB/FM antenna may be secured with a plastic cap - remove it before connecting the antenna. Otherwise the antenna may be damaged.

Connect the supplied indoor DAB/FM antenna to the DAB/FM Antenna Socket.

For better DAB/FM reception, we recommend using an outdoor DAB/FM antenna.

Note! Make sure the antenna is firmly installed - otherwise the signal reception may be unstable.

To avoid noises and distortions, keep the antenna away from the other cables in the system.

Connecting a USB Flash Drive

If you want to play digital audio files connect a USB Flash Drive to the USB Port.

Make sure that this CD-Receiver supports the files you want to play.

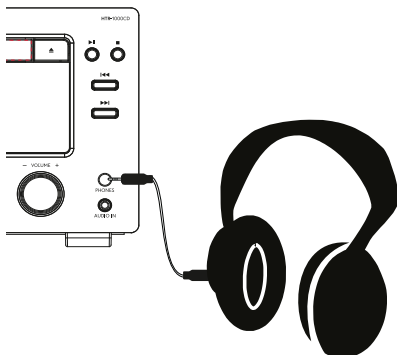
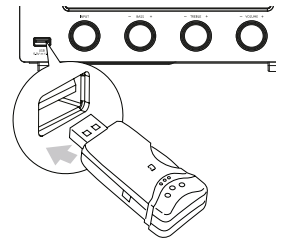

Connecting Headphones

If you want to listen to music via headphones: using a cable terminated with a 3.5 mm (1/8') jack plug, connect the headphones to the PHONES output.

Hooking up the CD-Receiver

Connecting Speakers

Using speaker cables connect your speakers to the SPEAKERS OUT connectors. Check "Hooking Up Speaker Cables" for more details.



Only speakers within the range of impedance 4 - 8ohm may be connected to this CD-Receiver.

Connecting speakers outside this range may damage this CD-Receiver and / or speakers.

This may void your warranty.

Connecting an Active Subwoofer

If you want to add an active subwoofer to your system: using an RCA-RCA or Y-type subwoofer interconnect connect the subwoofer to the SUB OUT output.

Please refer to your subwoofer instruction manual for more information.

Connecting Audio Equipment With Built-In Analog Output

If you want to play music from audio source devices equipped with an analog output (CD player, Satellite tuner, Network streamer, Music player, Smartphone, Laptop etc.) choose the corresponding interconnect cables and connect the devices to the analog inputs (AUDIO IN, AUX IN).













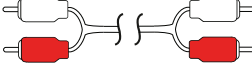

Check "External audio equipment connection options" for more details.

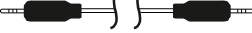
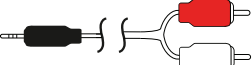
Connecting Audio Equipment With Built-In Digital Output

If you want to play a digital audio source (TV set, CD/DVD/Blu-ray player, video game console etc.) using a digital optical cable connect it to the digital optical input (OPTICAL).

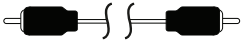
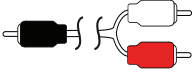
Hooking up the CD-Receiver

External audio equipment connection options:

Signal	Input / Output HTR-1000CD v.3	Input / Output external equipment	Connection cable
Analog	AUX IN input 	Output – RCA sockets 	RCA-RCA interconnect (1 pair supplied) 
	AUDIO IN input 	Outputs: 3.5 mm (1/8") socket  or RCA sockets 	3.5 mm mini jack - mini jack interconnect (not supplied)  3.5 mm mini jack - RCA interconnect (not supplied) 
	SUB OUT output 	Subwoofer inputs: SUB  or L/R 	RCA-RCA subwoofer interconnect (not supplied)  Y-type subwoofer interconnect (not supplied) 
Digital	OPTICAL input 	Optical socket 	Optical cable (not supplied) 

The sockets shown for external equipment and connection options may differ depending on the device.

Operation

Connecting to the Electrical Outlet

Plug the Power Cable to the CD-Receiver and into the electrical outlet.

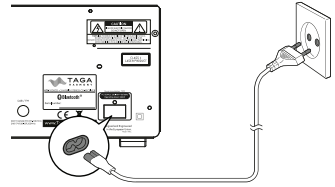

Your CD-Receiver is ready for operation.

Note! Check “Additional Information” for other useful operating instructions.

Display

In relation to the CD-Receiver features and operation, unless said otherwise, the square brackets [] indicate that the information they contain will be displayed on the Display.

ECO-Power/Standby and Automatic Standby features

Switching ON / OFF

When you connect the CD-Receiver to the electrical outlet for the first time and when switched on after a power failure, it will be in the Standby mode - [----:----] will be displayed.

- Press the **Standby** or select any input on the remote controller to switch the CD-Receiver on.

[TAGA HARMONY] will be displayed.

- [PREHEAT] will be displayed and a countdown of 10 seconds will start for preheating of the CD-Receiver.

Then, the CD-Receiver will switch to the last selected input.

- Press the **Standby** button to switch the CD-Receiver back to the Standby mode. [BYE BYE] will be displayed.

Switching the CD-Receiver to ECO Power/Standby mode

When the CD-Receiver is in one of the Standby modes (ECO Power or Normal) press and hold the **Standby** button for 2 seconds or more to switch between these modes.

• **ECO Power Standby mode**

After activating this mode, [ECO POWER] will be displayed and the ECO Power Standby Mode Indicator will be illuminated.

Then the Display will be turned off. The Clock will not be displayed.

Press the CLOCK button - the CD-Receiver will activate the Normal Standby mode and the Clock (if set) will be displayed for some time.

• **Normal Standby mode**

After activating this mode, the ECO Power Standby Mode Indicator is not illuminated and the following will be displayed: [----:----] - if the Clock is not set.

Time [hour:minute] - if the Clock is set.

After some time, the Display will be turned off and the CD-Receiver will automatically switch to the ECO Power Standby mode.

Note! The power consumption in the Normal Standby mode is higher than in the ECO Power Standby mode – check “Specifications” for more details.

Note! When switched off, the CD-Receiver will go to the Standby mode that was activated before switching on.

Operation

Automatic Standby Mode

To save energy, if there is no audio signal on active input (source) for approximately 15 minutes, the CD-Receiver will automatically switch to the Normal Standby mode, and then after some time to the ECO Power Standby mode.

Note! In some cases this feature may not be activated.

Setting the Clock

Setting the Clock Manually

1. In the Standby mode, press and hold the **CLOCK** button to activate the Clock setting mode, [CLOCK SET] will be displayed, then the time format [24] or [12] will blink.
2. Set the 12/24 hour format with the **▶▶I, I◀◀** buttons on the front panel, or **▶I, I◀** ; **VOL + / -** buttons on the remote controller.
3. Press the **CLOCK** button, the hour indicator will blink.
4. Set the hour with the **▶▶I, I◀◀** buttons on the front panel, or **▶I, I◀** ; **VOL + / -** buttons on the remote controller.
5. Press the **CLOCK** button, the minute indicator will blink.
6. Set the minute with the **▶▶I, I◀◀** buttons on the front panel, or **▶I, I◀** ; **VOL + / -** buttons on the remote controller.
7. Press the **CLOCK** button, the built-in clock starts operating.

Note!

- To exit the Clock setting mode without storing, press the **■** button.
- If no button is pressed within 10 seconds, the CD-Receiver exits the Clock setting mode automatically.
- If a power failure occurs or the CD-Receiver is disconnected from the electrical outlet, the Clock setting will be lost.

Setting the Clock Automatically

When the CD-Receiver is tuned in the DAB/RDS station station, you can synchronize with the time transmitted by the DAB/RDS station (with CT information).

Press the **INFO** button for over 2 seconds, [AUTO SYNC] will be displayed:

- » [CT SYNC] will be displayed after reading the DAB/RDS time.
- » If no time signal is received, [NO CT] will be displayed.

Display the Clock

In any Input mode, press the **CLOCK** button to display the time for a few seconds.

INPUT selection

By rotating the **INPUT** knob on the front panel or pressing the **INPUT** button or one of the functions buttons on the remote controller, select which audio input (source) you want to play.

Sequence of changes via the **INPUT** knob/button: DAB → DISC → USB → TUNER → BT → AUDIO IN → AUX → OPTICAL

Operation

A multi-functional button on the remote controller (**DAB/FM**) - repeatedly press the button until the required input is selected.

The selected input will be indicated on the Display.

Make sure the audio source is properly connected to the CD-Receiver and configured.

Note! In the Standby mode, selecting an audio input (source) on the remote controller, will switch the CD-Receiver on.

Sound Control

VOLUME regulation:

Using the **VOLUME** Regulator on the front panel or the **VOL +** and **VOL -** buttons on the remote controller, you can adjust the sound volume from minimum to maximum.

Note! While regulating the volume, you may hear the sound accompanying the level changing (from the speakers, headphones or through the SUB OUT), this is a normal phenomenon.



Too high volume level may result in deterioration of sound quality and distortion, which may damage the CD-Receiver and / or speakers - this may void your warranty. If you hear distortion or notice that the speakers are not working normally, turn down the volume immediately.

MUTE:

During playback press this button to stop the CD-Receiver audio output (no sound will be audible in speakers, headphones nor through the SUB OUT) - [MUTING] will blink. Press it again or use the volume regulation to recover the audio signal output back.

P-EQ presetting equalizer:

You can use one of 5 built-in equalizer presets to control the sound quality of the CD-Receiver.

During playback press the **P-EQ** button to select one of the presets.

Each pressing will select the subsequent preset from the below list:

FLAT - no icon

POP - **(POP)** icon displayed

JAZZ - **(JAZZ)** icon displayed

ROCK - **(ROCK)** icon displayed

CLASSIC - **(CLAS)** icon displayed

The icon of the selected P-EQ displayed with the input (source) name.

Note! The P-EQ function disengages the settings of the BASS / TREBLE regulation or the currently selected sound control function (LOUDNESS or S-BASS).

To switch off the P-EQ function, select one of sound control functions (LOUDNESS or S-BASS) or use the BASS / TREBLE regulation.

Operation

TREBLE regulation:

You can adjust treble output of the CD-Receiver in the range from -05 to +05.
The default is 0.

Front panel

Turn the knob counterclockwise (-) to decrease the amount of high frequencies.
Turn the knob clockwise (+) to increase the amount of high frequencies.

Remote controller

Press the BASS/TREBLE button to select this regulation.
Use the ►|, |◄ buttons to set the desired amount of high frequencies.
The current setting will be displayed.

Note! When one of the sound control functions (P-EQ, S-BASS or LOUDNESS) is selected, the current setting of the TREBLE regulation will be disengaged. Turn the knob or press the TREBLE button and use the ►|, |◄ buttons on the remote to switch off the selected sound control function and to restore the previous settings of the BASS/TREBLE regulation.

BASS regulation:

You can adjust bass output of the CD-Receiver in the range from -05 to +05.
The default is 0.

Front panel

Turn the knob counterclockwise (-) to decrease the amount of low frequencies.
Turn the knob clockwise (+) to increase the amount of low frequencies.

Remote controller

Press the BASS / TREBLE button to select this regulation.
Use the ►|, |◄ buttons to set the desired amount of low frequencies.
The current setting will be displayed.

Note! When one of the sound control functions (P-EQ, LOUDNESS or S-BASS) is selected, the current setting of the BASS regulation will be disengaged. Turn the knob or press the BASS button and use the ►|, |◄ buttons on the remote to switch off the selected sound control function and to get back to the BASS regulations.

S-BASS super bass:

The S-BASS function is used to reinforce the quality and strength of the bass output - it is intended only to be used at low listening levels.

The function is controlled by the S-BASS button.

S-BASS ON – [**DBB**] will be displayed.

To disengage the function, press the button until [OFF] is displayed.

Note! The S-BASS function disengages the settings of the BASS / TREBLE regulation or the currently selected sound control function (P-EQ or LOUDNESS).

Operation

LOUDNESS:

The LOUDNESS function boosts low and high frequencies - it is intended only to be used at low listening levels.

The function is controlled by the **LOUD** button.

LOUDNESS ON - [] will be displayed.

To disengage the function, press the button until [OFF] is displayed.

Note! The LOUDNESS function disengages the settings of the BASS / TREBLE regulation or the currently selected sound control function (P-EQ or S-BASS).



Using the P-EQ / BASS / TREBLE / LOUDNESS / S-BASS functions at high volume levels may damage this CD-Receiver and / or speakers. This may void your warranty.

Headphone Connection

Headphone connection (PHONES):

When headphones are plugged to the headphone output (Phones) the transmission of sound to the speakers and the subwoofer is switched off.

The speakers and the subwoofer will be active again after disconnecting the headphones.

The volume of the headphones is regulated by the volume regulation.

All sound regulations (P-EQ / BASS / TREBLE / LOUDNESS / S-BASS) will affect the sound transmitted to the headphones.



Listening at high volume may cause hearing damage.

Dimmer

DIMMER (DIM):

The DIMMER function is used to change the brightness of the Display.

The function is controlled by the **DIM** button.

Press the **DIM** button repeatedly to choose the brightness.

Operation

DAB Radio Operation

Note!

- Make sure that you have correctly connected and fully extended the antenna.
- You can program up to 30 DAB radio stations.
- National letters containing diacritical marks may not be displayed correctly.

Tuning in to a Station

1. Use the **INPUT** knob/button or press the **DAB/FM** button on the remote controller to select the DAB input. [DAB ] will be displayed.

When you switch the CD-Receiver on for the first time, [SCANNING] will be displayed and the device will search for the first available station.

If there is no signal, [NO DAB] will be displayed.

2. Select a station using one of the following methods:

• Manual Tuning

Repeatedly press the **▶▶I / I◀◀** buttons on the front panel or **▶▶ / ◀◀** buttons on the remote controller to change the frequency until you find the station you want.

• Preset Tuning (available only after the stations are programmed)

Repeatedly press the **0-9, 10+, PRESET ▶I / I◀** buttons to select the desired preset number.

The CD-Receiver will tune to the selected station automatically.

- If the preset number is less than 10, press the number buttons 1-9.
- If the preset number is 10 or higher, press the 10+ button and one of the number buttons 0-9.
- If the preset number is 20 or higher, press the 10+ button twice and one of the number buttons 0-9.
- If the preset number is 30, press the 10+ button three times and 0.

Program radio stations

• Automatically

Press the **SCAN** button once to activate the Scanning mode.

- [SCANNING] will blink.
- All available stations will be programmed and stored.
- The first programmed radio station will be broadcasted automatically.

• Manually

1. Tune in to a radio station.

2. Press the **PROG** button to activate the Program mode.

[P] and the preset number will blink.

3. Press the **PRESET ▶I / I◀** buttons to select a preset number for this radio station.

Note! If you select a number higher than 30, then the preset number will be changed to "1" automatically.

4. Press the **PROG** button again to store the station – [SAVED] will be displayed.

5. Repeat above steps 1 to 4 for each station you want to store in memory with a preset number.

Note! If a power failure occurs or the CD-Receiver is disconnected from the electrical outlet, the preset stations will not be erased.

Operation

DAB Information Display

Depending on the DAB radio station you are tuning to, some information may be unavailable.

Repeatedly press the **INFO** button to display the following information.

- **Station Name**

When an DAB station is received, the name of that station will be displayed.

- **Ensemble Name**

A multiplex is a collection of radio stations that are bundled and transmitted on one frequency. There are national and local multiplexes. Local ones contain stations that are specific to that area.

Note! DAB – unlike the normal radio, groups together several radio stations and transmits them on one frequency.

- **Clock**

Displays the current time provided automatically by the broadcaster.

- **Date**

Displays the current date provided automatically by the broadcaster.

- **DLS (Dynamic Label Segment)**

Dynamic label segment is a scrolling message that the broadcasters may include with their transmissions. The message usually includes information, such as program details etc.

- **Signal Strength**

Shows a number to indicate the signal strength which is between 0 and 100, for example 15, 80 or 100. The stronger the signal, the higher the number.

- **Program Type**

Describes the style or genre of the program that is being broadcast.

- **Frequency**

Displays the frequency of the current station.

- **Audio Bit Rate**

Displays the digital audio bit rate being received.

- **Stereo/Mono**

The Display will show if the station being received is in mono or stereo.

FM Radio Operation

Note!

- Make sure that you have correctly connected and fully extended the DAB/FM antenna.
- You can program up to 20 FM radio stations.
- National letters containing diacritical marks may not be displayed correctly.

Operation

Tuning in to a Station

1. Use the **INPUT** knob/button or press the **DAB/FM** button on the remote controller to select the TUNER input. [TUNER 

2. Select a station using one of the following methods:

- **Auto Tuning**

Press and hold the **▶▶I / I◀◀** buttons on the front panel or **◀◀ / ▶▶** buttons on the remote controller approximately one second and then release, the frequency changes down or up automatically until a station is found.

- **Manual Tuning**

Repeatedly press the **▶▶I / I◀◀** buttons on the front panel or **◀◀ / ▶▶** buttons on the remote controller to change the frequency until you find the station you want.

- **Preset Tuning (available only after the stations are programmed)**

Repeatedly press the **0-9, 10+, PRESET ▶I / I◀** buttons to select the desired preset number. The CD-Receiver will tune to the selected station automatically.

- If the preset number is less than 10, press the number buttons 1-9.
- If the preset number is 10 or higher, press the 10+ button and one of the number buttons 0-9.
- If the preset number is 20, press the 10+ button twice and 0.

Program radio stations

- **Automatically**

Press and hold the **PROG** button for 2 seconds or longer to activate the automatic Program mode.

- [AUTO] will be displayed.
- All available stations will be programmed and stored.
- The first programmed radio station will be broadcasted automatically.

- **Manually**

1. Tune in to a radio station.

2. Press the **PROG** button to activate the Program mode.

The preset number will blink.

3. Press the **PRESET ▶I / I◀** buttons to allocate a number to this radio station.

Note! If you select a number higher than 20, then the preset number will be changed to "1" automatically.

4. Press the **PROG** button again to store the station.

5. Repeat above steps 1 to 4 for each station you want to store in memory with a preset number.

Note! Use the **MODE** button to select Stereo or Mono signal.

Note! If a power failure occurs or the CD-Receiver is disconnected from the electrical outlet, the preset stations will not be erased.

RDS (Radio Data System) Reception

Many FM stations are broadcasting with added data compatible with RDS (Radio Data System).

Operation

Repeatedly press the **INFO** button to display the following information.

- **Station Name**
When an RDS station is received, the name of that station will be displayed.
- **PTY (Program Type)**
Describes the style or genre of the program that is being broadcast.
- **Clock**
Displays the current time provided automatically by the broadcaster. The RDS CLOCK system may not properly operate in areas where RDS CLOCK service is not available.
Once RDS CLOCK service is available, the RDS CLOCK system will start operation.
- **Text**
The broadcaster may include a message that displays information about the current program.
- **Frequency**
Displays the frequency of the current station.

CD Player Operation

Playback Memory

The CD-Receiver stores the last position played on the CD disc and the playback will be continued from that point. To erase the playback memory stop the playback using the **STOP** button or use another CD disc.

CD Playing

1. Use the **INPUT** knob/button or press the **CD** button on the remote controller to select the DISC input. [DISC ●] will be displayed.
2. Press the ▲ button to open the disc tray and place the CD disc on it (with the printed side up).
Note! If the disc tray is not closed manually within approximately 60 seconds, it will close automatically.
3. Press the ▲ button to close the disc tray, the player will read the disc and play it automatically.
Note! If in the Stop mode, please press the ►|| button to start playing the disc.
4. Press the ►|| button to temporarily stop the playing, press the button again, it will continue to play.
5. Press the ■ button to stop the disc playing.

CD AUDIO Information

The following information is displayed:

- During playing - the current track and its elapsed playing time. Repeatedly press the **INFO** button to display single elapsed time or single remain time or total elapsed time or total remain time.
- In the Stop mode - the total number of tracks and the total time of the disc.
- In the Pause mode - the selected time will blink.

To Skip or Search and Play

- Press the I◀◀ / ▶▶I buttons on the front panel or ►I / I◀ buttons on the remote controller once or more to skip previous/forward one or more tracks on the disc or

Operation

use the number buttons. To select track number 12, directly press 1, 2 buttons etc. Press and hold the **I◀◀ / ▶▶I** buttons on the front panel or **▶▶ / ◀◀** buttons on the remote controller to search for the position that you intend to start playing. Release to resume normal play.

Programme Play

You can programme up to 20 tracks to play in any desired order. The player must be in the Stop mode only with a CD disc inserted.

1. Insert a disc and press the **■** button when it starts playing.
2. Press the **PROG** button, [001 P--01] will be displayed.
3. Press the **I◀◀ / ▶▶I** buttons on the front panel or **0-9, ▶I / I◀** buttons on the remote controller to select the desired track number.
 - To select track number 12, directly press 1, 2 buttons etc.
4. Press the **PROG** button to confirm the track number to be stored.
5. Repeat steps 3-4 to select and store all desired tracks.
6. Press the **▶II** button to start the programme play.
7. Press the **■** button once to stop the programme play.

Press the **■** button twice to clear the programme, [PRG CLR] will be displayed.

Note! During the Programme Play, [PROG] will be displayed.

Repeat and shuffle play (CD disc)

- During playing - ONE/ALL Repeat Play and Shuffle Play can be set by pressing the **MODE** button.
 - First press: to repeat the same track, [RPT ONE] will be displayed for a while and the [REP] icon will stay displayed as long as the function is active.
 - Second press: to repeat all tracks on a disc, [RPT ALL] will be displayed for a while and the [REP ALL] icons will stay displayed as long as the function is active.
 - Third press: to play all tracks randomly (shuffle mode), [SHUF ON] will be displayed for a while and the [SHUF] icon will stay displayed as long as the function is active.
 - Fourth press: to cancel the shuffle mode. [SHUF OFF] will be displayed.

MP3/WMA Disc Playing

Note! Correct MP3/WMA music playback from CD depends on the type and format of the disc and the condition of individual recordings.

If you are having trouble playing a certain disc, it is recommended to use the USB input instead.

1. Use the **INPUT** knob/button or press the **CD** button on the remote controller to select the DISC input. [DISC ●] will be displayed.
2. Press the **▲** button to open the disc tray and place the MP3/WMA disc on it (with the printed side up).

Note! If the disc tray is not closed manually within approximately 60 seconds, it will close automatically.

3. Press the **▲** button to close the disc tray, the player will read the disc and play it automatically.

Note! If in the Stop mode, please press the **▶II** button to start playing the disc.

4. Press the **▶II** button to temporarily stop the playing, press the button again, it will continue to play.
5. Press the **■** button to stop the disc playing.

Operation

CD MP3/WMA CD Information

The following information is displayed:

- During playing - the current file number and its elapsed playing time. Repeatedly press the **INFO** button to display the title, artist and album name (if they are available).
- In the Stop mode - the total number of folders and files.
- In the Pause mode – the file elapsed time will blink.

Note! For some content the information may be not available or maybe not accurate.

To Skip or Search and Play

- Press the **|◀◀ / ▶▶|** buttons on the front panel or **▶| / |◀** buttons on the remote controller once or more to skip previous/forward one or more files on the disc or use the number buttons. To select file number 12, directly press 1, 2 buttons etc.
- Press and hold the **|◀◀ / ▶▶|** buttons on the front panel or **▶▶ / ◀◀** buttons on the remote controller to search for the position that you intend to start playing. Release to resume normal play.

Programme Play

You can programme up to 20 files to play in any desired order.

The player must be in the Stop mode only with a CD disc inserted.

1. Insert a disc and press the **■** button when it starts playing.
 2. Press the **PROG** button, [001 P--01] will be displayed.
 3. Press the **ALB+/-** buttons to select a folder.
 4. Press the **|◀◀ / ▶▶|** buttons on the front panel or **0-9, ▶| / |◀** buttons on the remote controller to select the desired file number.
To select file number 12, directly press 1, 2 buttons etc.
 5. Press the **PROG** button to confirm the file number to be stored.
 6. Repeat steps 3-4 to select and store all desired files.
 7. Press the **▶||** button to start the programme play.
Press the **■** button once to stop the programme play.
Press the **■** button twice to clear the programme, [PRG CLR] will be displayed.
- Note!** During the Programm Play, [PROG] will be displayed.

Access a folder

- During playing, press the **ALB+/-** buttons to select a folder.
- In the Stop mode, press the **ALB+/-** buttons to select a folder and press the **|◀◀ / ▶▶|** buttons on the front panel or **▶| / |◀** buttons on the remote controller to select a file, and then press the **▶||** button to start playing.

Repeat and shuffle play (MP3/WMA disc)

- During playing - ONE/ALL/ALBUM(FOLDER) Repeat Play and Shuffle Play can be set by pressing the **MODE** button.
 - First press: To repeat the same file, [RPT ONE] will be displayed for a while and the [REP] icon will stay displayed as long as the function is active.
 - Second press: To repeat playing all files on a disc, [RPT ALL] will be displayed for a while and the [REP ALL] icons will stay displayed as long as the function is active.
 - Third press: to repeat a folder, [RPT ALB] will be displayed for a while and the [REP ALB] icons will stay displayed as long as the function is active.
 - Fourth press: to play all files randomly (shuffle mode), [SHUF ON] will be displayed for a while and the [SHUF] icon will stay displayed as long as the function is active.
 - Fifth press: to cancel the shuffle mode. [SHUF OFF] will be displayed.

Play from a USB Flash Drive



Maximum supported USB flash drive capacity is 64GB.
Not all USB flash drives may be compatible and supported.

Playback Memory

The CD-Receiver stores the last position played on the USB Flash Drive and the playback will be continued from that point. To erase the playback memory stop the playback using the ■ button or use another USB Flash Drive.

1. Insert a USB Flash Drive into the USB port.
2. Use the **INPUT** knob/button or press the **USB** button on the remote controller to select the USB input. [USB - 3. If supported file formats are found, the playback will start automatically.
- 4. During playing, press the ►|| button to temporarily pause the playing, press the button again to continue playing.
- 5. Press the ■ button to stop playing.
Press the ►|| button to start playing.

USB Flash Drive Information

The following information is displayed:

- During playing - the current file and its elapsed playing time.
- In the Stop mode - the total number of folders and files.
- In the Pause mode - [PAUSE] will be displayed.

Note! Metadata (such as title/artist/album names) is not supported.

To Skip or Search and Play

- Press the |◀◀ / ▶▶| buttons on the front panel or ►| / |◀ buttons on the remote controller once or more to skip previous/forward one or more files on the disc or use the number buttons. To select file number 12, directly press 1, 2 buttons etc.
- Press and hold the |◀◀ / ▶▶| buttons on the front panel or ▶▶ / ◀◀ buttons on the remote controller to search for the position that you intend to start playing.
Release to resume normal play.

Programme Play

You can programme up to 20 files to play in any desired order.

The USB Flash Drive must be inserted in the USB port.

1. Insert the USB Flash Drive and press the ■ button when it starts playing.
2. Press the **PROG** button, [01 P--01] will be displayed.
3. Press the |◀◀ / ▶▶| buttons on the front panel or **0-9**, ►| / |◀ buttons on the remote controller to select the desired file number.
 - To select file number 12, directly press 1, 2 buttons etc.

Note! Files are selected from all albums.

4. Press the **PROG** button to confirm the file number to be stored.
 5. Repeat steps 3-4 to select and store all desired files.
 6. Press the ►|| button to start the programme play.
Press the ■ button once to stop the programme play.
Press the ■ button twice to clear the programme, [PRG CLR] will be displayed.
- Note!** During the Programme Play, [PROG] will be displayed.

Play from a USB Flash Drive

Access a folder

- During playing, press the **ALB+/-** buttons to select a folder.
- In the Stop mode, press the **ALB+/-** buttons to select a folder and press the **I◀◀ / ▶▶I** buttons on the front panel or **▶I / I◀** buttons on the remote controller to select a file - the playback will start automatically.

Repeat and shuffle play

- During playing - ONE/ALL/ALBUM(FOLDER) Repeat Play and Shuffle Play can be set by pressing the **MODE** button.
 - First press: To repeat the same file, [RPT ONE] will be displayed for a while and the [REP] icon will stay displayed as long as the function is active.
 - Second press: To repeat playing all files on a disc, [RPT ALL] will be displayed for a while and the [REP ALL] icons will stay displayed as long as the function is active.
 - Third press: to repeat a folder, [RPT ALB] will be displayed for a while and the [REP ALB] icons will stay displayed as long as the function is active.
 - Fourth press: to play all files randomly (shuffle mode), [SHUF ON] will be displayed for a while and the [SHUF] icon will stay displayed as long as the function is active.
 - Fifth press: to cancel the shuffle mode. [SHUF OFF] will be displayed.



Depending on the USB Flash Drive type, format and number or arrangements of folders and files some music files may be played in different order or may not be recognized by the CD-Receiver.



We recommend to change the USB source to another one before removing the USB Flash Drive.

Play from a USB Flash Drive

Supported File Formats

The CD-Receiver can only play files in AAC-LC, APE, FLAC, MP3, WAV, WMA formats.

Note! Depending on the sampling rate (kHz), bitrate (kbps) and other parameters, some files in listed formats may not be played - for more information check product page on www.TagHarmony.com. If a USB Flash Drive contains unsupported files then it may obstruct the CD-Receiver operation - make sure to remove such files.

Charging a Mobile Device via USB

To charge a mobile device use a USB cable and connect it to the USB port.

Charging is also available in both standby modes.

Note! Charging in the standby mode increases the energy consumption of the CD-Receiver.



The maximum current for USB charging is 5.0V 1.0A.



Some mobile devices may not be charged.

Play via *Bluetooth*[®]



Use the **INPUT** knob/button or press the  button on the remote controller to select the BT input.

[BT 

DEVICE NAME

The CD-Receiver **Bluetooth**[®] device name is “HTR-1000CD v.3”.

PAIRING

1. As long as the same audio source device is being used with the CD-Receiver, pairing needs only to be done once.
2. If no audio source device is paired and connected with the CD-Receiver, then [BT - 3. Activate and select **Bluetooth**[®] on your audio source device (smartphone, laptop etc.) and start scanning for available **Bluetooth**[®] devices.
- 4. After a short time “HTR-1000CD v.3” will appear on the screen of your audio source.
- 5. Select “Pair” on your audio source device to connect with the CD-Receiver.
After connection is successful [PAIRED] will be displayed for a while, and [BT 

Note! For elder audio source devices, you may need to input “0000” as a pairing password.

Note! Some audio source devices may not be compatible.





6. If you disconnect the active **Bluetooth**[®] connection on your audio source device, then [BT READY] will be displayed, and then [BT - 7. The CD-Receiver will now be ready to play your music wirelessly within a range of approximately 5 meters. Start playback on your audio source device.

Note! If you want to disconnect the active **Bluetooth**[®] connection and pair a new audio source device, press and hold the [PAIRING] button until [BT READY] will be displayed, and then [BT 

CONTROL FROM THE CD-RECEIVER

You may control the playback on your audio source device and for basic functions from the CD-Receiver.

Note! Not all audio sources may be controlled by the CD-Receiver.

- To pause/resume play, press .
- To skip to a track, press   on the front panel or   on the remote controller.

PAIRING HISTORY CLEARING

When in the [BT] press the  button for 3 seconds or longer to clear **Bluetooth**[®] connected history – [BT CLEAR] will be displayed.

Note! Please refer to your audio source user instruction for details on operating the **Bluetooth**[®].

Operation and names of specific functions may vary on different devices.

Play via *Bluetooth*[®]

Important Notes - Bluetooth[®] Connection

1. When you want to use another **Bluetooth[®]** audio source than currently active, you have to disconnect the active connection and start the **Bluetooth[®]** connection procedure.
2. Make sure that there are no objects placed between an audio source and the CD-Receiver obscuring the **Bluetooth[®]** signal which may result in unstable or no connection.
3. This unit supports A2DP (Advanced Audio Distribution Profile).

Note! The above listed functionality may vary on different **Bluetooth[®]** audio sources (smartphones, computers or other compatible devices).

For some audio source devices it may take a shorter or longer period of time to reconnect to the CD-Receiver or it may even require to repeat the pairing procedure each time the **Bluetooth[®]** connection is lost.

Note! If your **Bluetooth[®]** audio source is not able to find the “HTR-1000CD v.3” device or connect to it then switch off, clear the pairing history and repeat the pairing procedure.

Setting the Sleep Timer

When the CD-Receiver is turned on, repeatedly press the **TIMER/SLEEP** button to select a set period of time (in minutes): 120, 90, 60, 45, 30, 15.

When the Sleep Timer is activated, [SLEEP] will be displayed.

Note! When the Sleep Timer is activated, press the **TIMER/SLEEP** button to display the remaining time (it will be automatically displayed around 60 seconds before the Sleep Timer is engaged).

To deactivate the Sleep Timer

Press the **TIMER/SLEEP** button repeatedly until [SLEEP OFF] will be displayed.

Setting the Alarm Timer

The CD-Receiver can be used as an alarm timer (clock) for the following inputs: DISC, DAB, TUNER, USB.

Note!

- * Setting the Alarm Timer is only available in the Standby Mode.
 - * Make sure that you have set the Clock correctly.
 - * To set the alarm timer, make sure to display the current time (press **CLOCK**) or activate the Normal Standby Mode.
1. Press and hold the **TIMER/SLEEP** button, until [TIMER SET] scrolls and the input will be displayed, e.g. DISC.
 2. Use the ►►|, |◄◄ buttons on the front panel, or ►|, |◄ ; **VOL + / -** buttons on the remote controller to select an input.
 3. Press the **TIMER/SLEEP** button, the hour indicator will blink.
 4. Repeat steps 2-3 to set the hour, minute and adjust the volume.

If the Alarm Timer is activated, then in the Normal Standby mode [] will be displayed.

Note! After the CD-Receiver is activated by the Alarm Timer, the volume level will be gradually increased until it reaches the set level.

Adjusting the volume regulation manually will stop increasing.

Note!

- To exit the Alarm Timer setting mode without storing, press the **■** button.
- If no button is pressed in 10 seconds, the CD-Receiver exits the Clock setting mode automatically.
- If the CD or USB input is selected, and no disc or a USB Flash Drive is inserted or an incompatible format is detected, the TUNER input will be activated automatically.

To deactivate or re-activate the Alarm Timer

In the Normal Standby mode, press the **TIMER/SLEEP** button to activate or deactivate the Alarm Timer.

- If the Alarm Timer is activated, [] and the set time (for a while) will be displayed.

Additional Information

Break-In

Your TAGA Harmony CD-Receiver sounds great immediately after it is taken out of the carton but as all hybrid devices, this CD-Receiver requires a “break-in” period to reach its full sonic capabilities.

During the “break-in” period it is recommended to operate the CD-Receiver at moderate volume levels.

The first level of the “break-in” is reached after approximately 10 hours of play.

The optimal level of the “break-in” is reached after approximately 40 to 60 hours of play.

It is recommended to avoid one-time short periods of operation unless the CD-Receiver reaches the first “break-in” level.

When the CD-Receiver is turned on, it should operate for around 1-2 hours.

Turn off procedure



If the CD-Receiver was turned off even for a short period of time, you should wait at least 2 minutes before turning it back on.
Do not turn it ON then OFF and then ON again in quick succession.

Follow this procedure each time you turn your CD-Receiver OFF / ON.

This precaution will minimize the stress (high voltages) on internal components.

Vacuum tubes - noise floor and interferences

It is a normal phenomenon for an CD-Receiver equipped with vacuum tubes to produce significant amount of noise (called noise floor or self-noise) which can be audible in speakers and headphones (in one or both channels).

Devices equipped with vacuum tubes are more prone to various types of interferences generated by nearby electronic equipment – try to eliminate such a problem by moving this product away from the source of interference or trying to power it from a different power line than other equipment (e.g. from a power outlet in another room).

Vacuum Tube Replacement

The lifetime of vacuum tubes may vary and depends on their operation time and ambient temperature, playback volume levels and the number of on and off cycles.

Replacement vacuum tubes are not supplied with this product.



The warranty time for vacuum tubes is shorter than for other components of this device – for more details check your warrant terms or contact a local dealer.



The vacuum tubes are installed inside the device and should be replaced only by qualified service personnel.

Additional Information

Power transformer – Power filters and conditioners

It is a normal phenomenon that the device's power transformer may generate a certain amount of audible noise.

Very loud operation of the power transformer may be caused by low quality of power supply (voltage surges etc.).

In such a case, we suggest using a power filter or conditioner - you can also try to power this product from a different power line than other devices (e.g. from a power outlet in another room).

Handling of CD discs

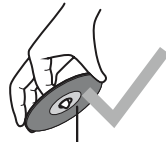

Playback side



- Do not touch the playback side of the disc.
- Do not attach paper or tape to the disc.

Cleaning Discs



- Fingerprints and dust on the disc cause picture and sound deterioration. Wipe the disc from the centre outwards with a soft cloth. Always keep the disc clean.
- If you cannot wipe off the dust with a soft cloth, wipe the disc lightly with a slightly moistened cloth and finish with a dry cloth.
- Do not use any type of solvent such as thinner, benzene, commercially available cleaners or antistatic spray. They may damage the disc.

Storing Discs

- Do not store discs in places subjected to direct sunlight or near heat sources.
- Do not store discs in places subjected to moisture and dust such as a bathroom or near a humidifier.
- Storing discs vertically in a case, stacking discs or placing objects on discs outside of their cases may cause warping.

Trademarks and Software Notice

All trademarks and trade names used in this manual are those of their respective owners.

- **Bluetooth®** is a registered trademark of Bluetooth SIG, Inc.

Kit Content:

CD-Receiver	1 EA
Remote Controller (2 batteries included)	1 EA
DAB/FM Antenna	1 EA
Power Cable	1 EA
RCA-RCA interconnect	1 PAIR
Instruction Manual	1 EA

Specifications

We strongly advise to contact a professional installer or dealer in order to install TAGA Harmony products.

We recommend using high quality TAGA Harmony cables and other installation accessories.

Specifications

Vacuum tubes	2 x ECC83 PSVANE Classic Series
Power output / impedance	2 x 90W RMS 4ohm
Compatible CD formats	CD-Audio, CD-R/RW (audio files MP3, WMA)
Radio section	Tuner: FM (87.5 - 108MHz) RDS DAB+ (174.928 - 239.200 MHz) Preset: 20 FM / 30 DAB+ DAB/FM antenna impedance: 75ohm
Wireless connectivity	Bluetooth® Frequency Range: 2402 - 2480MHz Max EIRP: -1.09dBm
Internet radio	Yes
Digital inputs	USB (AAC-LC, APE, FLAC, MP3, WAV, WMA) Optical (192kHz/24bit)
Analog inputs	AUX Stereo Jack 3.5mm (front panel)
Analog outputs	Subwoofer (frequency: 20 - 300Hz)
Headphone output	Impedance: 32ohm Output power: <10mW, 32ohm
Frequency response	30Hz - 20KHz (>-6dB)
Total Harmonic Distortions	≤1%
Signal/Noise ratio	>60dB
AC power / power consumption	220-240V 50/60Hz Power consumption: 70W Power consumption ECO Standby Mode: <0.5W Power consumption Normal Standby Mode: <4W Operating (max): 300W
Charging	Via USB Port: max. 5.0V 1.0A
Dimensions (H x W x D)	14 x 24.5 x 29.5 cm
Weight	5.9 kg / pc.

We reserve the right to change the technical data and the design of the product without notice as a result of further development.



RF Radiation Exposure Statement

This equipment complies with radiation exposure limits set forth for an uncontrolled environment. This equipment should be installed and operated with a minimum distance of 20cm between the radiator and any part of your body.

EU declaration of conformity



Your product is marked with the symbol shown on the left. As its manufacturer, hereby we declare that the product is in compliance with the following EU directives and regulations:
2014/35/EU (LVD) & 2014/53/EU (RED) & 1275/2008/EC (ErP) & 2015/863/EU (RoHS)

The full text of the EU declaration of conformity is available from the manufacturer.

Disposal of the product



Disposal of old electrical & electronic equipment (applicable in the European Union and other countries with separate collection systems)

This symbol on the product or on its literature and packaging indicates that this product shall not be treated as household waste. Instead it shall be handed over to the appropriate collection point for the recycling of electrical and electronic equipment. By ensuring that this product is disposed of correctly, you will help to prevent potential negative consequences for the environment and human health, which could be caused by inappropriate waste handling of this product. The recycling of materials will help to conserve natural resources. For more detailed information about recycling of this product, please contact your local government office, your household waste disposal service or the shop where you purchased the product.



Disposal of waste batteries (applicable in the European Union and other countries with separate collection systems)

This symbol on the battery or on the packaging indicates that the battery provided with this product shall not be treated as household waste. On certain batteries this symbol might be used in combination with a chemical symbol. The chemical symbol for lead (Pb) is added if the battery contains more than 0.004 % lead. By ensuring that these batteries are disposed of correctly, you will help to prevent potentially negative consequences for the environment and human health which could be caused by inappropriate waste handling of the battery. The recycling of the materials will help to conserve natural resources. In case of products that for safety, performance or data integrity reasons require a permanent connection with an incorporated battery, this battery should be replaced by qualified service staff only. To ensure that the battery will be treated properly, hand over the product at end-of-life to the appropriate collection point for the recycling of electrical and electronic equipment. For all other batteries, please view the section on how to remove the battery from the product safely. Hand the battery over to the appropriate collection point for the recycling of waste batteries. For more detailed information about recycling of this battery, please contact your local government office, your household waste disposal service or the shop where you purchased the product or battery.

TAGA EUROPE

POLPAK POLAND Sp. z o.o.
AL.JEROZOLIMSKIE 331A
05-816 REGULY k/WARSZAWY, POLAND
Email: Sales@TagaHarmony.com

www.TagaHarmony.com

Notes
