

**8-Port 10/100/1000T 802.3at PoE +  
2-Port 10/100/1000T Desktop Switch**

**GSD-1008HP**

User's Manual

## **Copyright**

Copyright © 2020 by PLANET Technology Corp. All rights reserved. No part of this publication may be re-produced, transmitted, transcribed, stored in a retrieval system, or translated into any language or computer language, in any form or by any means, electronic, mechanical, magnetic, optical, chemical, manual or otherwise, without the prior written permission of PLANET.

PLANET makes no representations or warranties, either expressed or implied, with respect to the contents hereof and specifically disclaims any warranties, merchantability or fitness for any particular purpose. Any software described in this manual is sold or licensed "as is". Should the programs prove defective following their purchase, the buyer (and not PLANET, its distributor, or its dealer) assumes the entire cost of all necessary servicing, repair, and any incidental or consequential damages resulting from any defect in the software. Further, PLANET reserves the right to revise this publication and to make changes from time to time in the contents hereof without obligation to notify any person of such revision or changes.

All brand and product names mentioned in this manual are trademarks and/or registered trademarks of their respective holders.

## **Trademarks**

PLANET is a registered trademark of PLANET Technology Corp.

All other trademarks belong to their respective owners

## **Disclaimer**

PLANET Technology does not warrant that the hardware will work properly in all environments and applications, and makes no warranty and representation, either implied or expressed, with respect to the quality, performance, merchantability, or fitness for a particular purpose.

PLANET has made every effort to ensure that this User's Manual is accurate; PLANET disclaims liability for any inaccuracies or omissions that may have occurred. Information in this User's Manual is subject to change without notice and does not represent a commitment on the part of PLANET. PLANET assumes no responsibility for any inaccuracies that may be contained in this User's Manual. PLANET makes no commitment to update or keep current the information in this User's Manual, and reserves the right to make improvements to this User's Manual and/or to the products described in this User's Manual, at any time without notice. If you find information in this manual that is incorrect, misleading, or incomplete, we would appreciate your comments and suggestions.

## FCC Warning

This equipment has been tested and found to comply with the limits for a Class A digital device, pursuant to Part 15 of the FCC Rules. These limits are designed to provide reasonable protection against harmful interference when the equipment is operated in a commercial environment. This equipment generates, uses, and can radiate radio frequency energy and, if not installed and used in accordance with the Instruction manual, may cause harmful interference to radio communications. Operation of this equipment in a residential area is likely to cause harmful interference in which case the user will be required to correct the interference at his own expense.

## CE Mark Warning

This is a Class A product. In a domestic environment, this product may cause radio interference, in which case the user may be required to take adequate measures.

## WEEE Warning



To avoid the potential effects on the environment and human health as a result of the presence of hazardous substances in electrical and electronic equipment, end users of electrical and electronic equipment should understand the meaning of the crossed-out wheeled bin symbol. Do not dispose of WEEE as unsorted municipal waste and have to collect such WEEE separately.

## Revision

PLANET 8-Port 10/100/1000T 802.3at PoE + 2-Port 10/100/1000T Desktop Switch User's Manual.

For Model: GSD-1008HP

Revision: 2.0 (August 2020)

Part No.: EM-GSD-1008HP\_v2.0

# Table Of Contents

1. Introduction .....	5
1.1 Checklist.....	5
1.2 Product Description.....	5
1.3 Features .....	6
1.4 Specifications .....	7
2. Hardware Description .....	9
2.1 Front Panel .....	9
2.1.1 LED Indicators .....	11
2.2 Rear Panel .....	11
3. Hardware Installation .....	12
3.1 Desktop Installation .....	13
3.2 Rack Mounting .....	14
3.3 Wall Mounting Installation .....	15
4. Troubleshooting .....	17
Appendix A - Networking Connection.....	18
A.1 Switch's Data RJ45 Pin Assignments - 1000Mbps, 1000BASE-T .....	18
A.2 10/100Mbps, 10/100BASE-TX .....	18

# 1. Introduction

## 1.1 Checklist

Check the contents of your package for the following parts:

<p>GSD-1008HP x 1</p> 	<p>User's Manual x 1</p> 
<p>Power Cord x 1</p> 	<p>Rubber Feet x 4</p> 
<p>Rack-mounting Brackets</p> 	<p>Screws Package x 8</p> 

If any item is found missing or damaged, please contact your local reseller for replacement.

## 1.2 Product Description

To fulfill the demand of sufficient PoE power for network applications with Gigabit speed transmission, PLANET GSD-1008HP 8-Port 10/100/1000T 802.3at PoE + 2-Port 10/100/1000T Desktop Switch, a new member of the 802.3at PoE Gigabit Ethernet Switch family, features up to 32 watts of power output for each port and a total PoE budget of 120 watts for eight 10/100/1000Mbps TP ports, and two 10/100/1000Mbps uplink ports. The eight 802.3at PoE+ ports provide PoE power

injector function which is able to drive 8 IEEE 802.3at compliant powered devices. The GSD-1008HP also provides a simple, cost-effective, and non-blocking wire-speed performance with 9-inch metal housing suitable for desktop deployment for SOHO and department network applications.

All RJ45 copper interfaces in the GSD-1008HP support 10/100/1000Mbps auto-negotiation for optimal speed detection through RJ45 Category 5, 5e or 6 cables. It also supports standard auto-MDI/MDI-X that can detect the type of connection to any Ethernet device without requiring special straight-through or crossover cables.

## 1.3 Features

### ➤ Physical Port

- 10-port 10/100/1000BASE-T Gigabit Ethernet RJ45 copper
- 8-port IEEE 802.3af/at PoE Injector (Port-1 to Port-8)

### ➤ Power over Ethernet

- Complies with IEEE 802.3af/at Power over Ethernet end-span PSE
- Up to 8 ports of IEEE 802.3af/at devices powered
- Supports PoE Power up to 32 watts for each PoE port
- Each port supports 54V DC power to PoE powered device
- 120-watt PoE budget
- Auto detects powered device (PD)
- Supports PD alive function
- Circuit protection prevents power interference between ports
- Remote power feeding up to 100m in standard mode with 250m in extended mode

### ➤ Switching

- Hardware-based 10/100/1000Mbps auto-negotiation and auto MDI/MDI-X
- Flow control for full duplex operation and back pressure for half duplex operation
- Integrates address look-up engine, supporting 2K absolute MAC addresses
- 9K jumbo frame supports all speeds (10/100/1000Mbps)
- Hardware DIP switch for **Standard**, **VLAN** and **Extend** mode selection; the Extend mode features 20-watt PoE transmit distance of 250m at speed of 10Mbps and VLAN isolation (Only for Port-1 to Port-8)
- Solid DIP switch to isolate ports to prevent broadcast storm and defend DHCP spoofing

➤ Hardware

- 9-inch desktop size, 1U height, rack mountable
- LED indicators for system power, per port PoE ready and PoE activity, speed, Link/Act
- 1 silent fan to provide stable and efficient power performance
- Supports Energy-Efficient Ethernet (EEE) function (IEEE 802.3az)

## 1.4 Specifications

Model	GSD-1008HP
Hardware Specifications	
Copper Port	10 10/100/1000BASE-T MDI/MDIX Ports
PoE Injector Port	8-port with 802.3af/at PoE injector function with Port-1 to Port-8
Switch Architecture	Store-and-Forward
Switch Fabric	20Gbps/non-blocking
Switch Throughput@64 bytes	13.4Mpps@64 bytes
MAC Address Table	2K entries, automatic source address learning and aging
Maximum Frame Size	9K bytes
Flow Control	IEEE 802.3x pause frame for full-duplex Back pressure for half-duplex
LED	<b>System:</b> <ul style="list-style-type: none"><li>■ Power (Green)</li></ul> <b>10/100/1000BASE-T RJ45 interfaces:</b> <ul style="list-style-type: none"><li>■ 10/100/1000Mbps LNK/ACT (Green)</li></ul> <b>PoE interfaces:</b> <ul style="list-style-type: none"><li>■ PoE-in-Use (Amber)</li></ul>
DIP Switch	Selectable operation mode <ul style="list-style-type: none"><li>■ Standard</li><li>■ VLAN</li><li>■ Extend</li></ul>
Dimensions (W x D x H)	220 x 150 x 43 mm (1U height)
Enclosure	Metal

Weight	1205 g
Power Requirements	AC 100~240V, 50/60Hz, 2.5A max.
Power Consumption/Dissipation	Max. 120 watts/409.4 BTU
Thermal Fan	1
Power over Ethernet	
PoE Standard	IEEE 802.3af Power over Ethernet/PSE IEEE 802.3at Power over Ethernet Plus/PSE
PoE Power Supply Type	End-span
PoE Power Output	Per port 54V DC, 600mA. max. 32 watts
Power Pin Assignment	1/2(+), 3/6(-)
PoE Power Budget	120 watts
Max. Number of Class 2 PDs	8
Max. Number of Class 3 PDs	8
Max. Number of Class 4 PDs	4
Standards Conformance	
Regulatory Compliance	FCC Part 15 Class A, CE
Standards Compliance	IEEE 802.3 10BASE-T IEEE 802.3u 100BASE-TX IEEE 802.3ab Gigabit 1000BASE-T IEEE 802.3x Flow control and back pressure IEEE 802.3af Power over Ethernet IEEE 802.3at Power over Ethernet Plus IEEE 802.3az Energy Efficient Ethernet (EEE)
Environment	
Operating	Temperature: 0 ~ 50 degrees C Relative Humidity: 5 ~ 95% (non-condensing)
Storage	Temperature: -10 ~ 70 degrees C Relative Humidity: 5 ~ 95% (non-condensing)



## 2. Hardware Description

The switch provides three different running speeds – 10Mbps, 100Mbps and 1000Mbps, and automatically distinguishes the speed of the incoming connection.

This section describes the hardware features of the GSD-1008HP. For easier management and control of the GSD-1008HP, familiarize yourself with its display indicators and ports. Front panel illustrations in this chapter display the unit LED indicators. Before connecting any network device to the GSD-1008HP, please read this chapter carefully.

### 2.1 Front Panel

The front panel of the GSD-1008HP PoE+ Ethernet Switch consists of 10 auto-sensing 10/100/1000Mbps Ethernet RJ45 ports. The LED indicators are also located on the front panel of the GSD-1008HP.

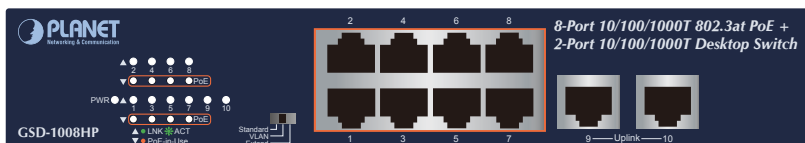



Figure 2-1: GSD-1008HP Switch Front Panel

The front panel of GSD-1008HP provides one DIP switch for **Standard**, **VLAN** and **Extend** mode selections. The detailed descriptions are shown in the following table.

DIP Switch Mode	Function
 <p>Standard VLAN Extend</p>	<p>This mode makes the GSD-1008HP operate as a general switch and all PoE ports operate at 10/100/1000Mbps auto-negotiation.</p>
 <p>Standard VLAN Extend</p>	<p>This mode makes the GSD-1008HP operate as a <b>VLAN isolation</b> switch and</p> <ol style="list-style-type: none"> <li>1. Port 1 to port 8 will isolate respectively.</li> <li>2. Port 1 to port 8 can only communicate with port 9 and port 10 (uplink port).</li> </ol>



This mode makes the GSD-1008HP operate as a VLAN isolation switch and

1. Port 1 to port 8 will isolate respectively.
2. Port 1 to port 8 can only communicate with port 9 and port 10 (uplink port).
3. 20-watt PoE transmit distance of 250m at speed of 10Mbps.

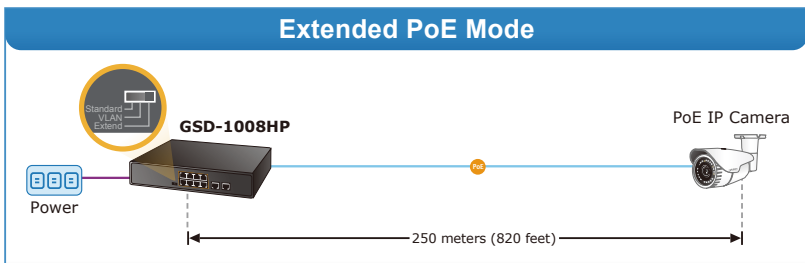
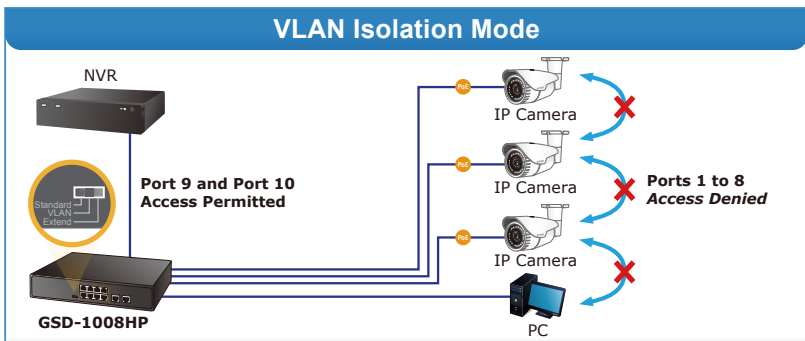
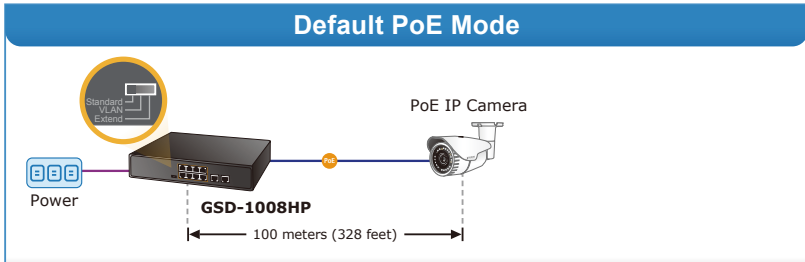

## 2.1.1 LED Indicators

### ■ System

LED	Color	Function
PWR	Green	Lights to indicate that the Switch has power.

### ■ Per 10/100/1000Mbps Port

LED	Color	Function
PoE-in-use	Amber	Lights to indicate the port is providing 54V DC in-line power. (1-8 ports)
Speed/ LNK/ACT	Green	Lights to indicate the Switch is successfully connecting to the network at 10/100/1000Mbps. Blinks to indicate that the Switch is actively sending or receiving data over that port.

## 2.2 Rear Panel

The rear panel of the GSD-1008HP has an AC inlet power socket, which accepts input power of 100 to 240V AC, 50-60Hz, and a maximum of 2.5A.



**Figure 2-2:** GSD-1008HP Switch Rear Panel



### Power Note

1. The device is a power-required device which means it will not work till it is powered. If your networks should be active all the time, please consider using UPS (Uninterrupted Power Supply) for your device. It will prevent you from network data loss or network downtime.
2. In some areas, installing a surge suppression device may also help to protect your GSD-1008HP from being damaged by unregulated surge or current to the GSD-1008HP.

### 3. Hardware Installation

#### Start up

Please refer to the following for your cabling:

##### ■ 10/100/1000BASE-T

All 10/100/1000BASE-T ports come with auto-negotiation capability. They automatically support 1000BASE-T, 100BASE-TX and 10BASE-T networks. Users only need to plug a working network device into one of the 10/100/1000BASE-T ports, and then turn on the GSD-1008HP. The port will automatically run at 10Mbps, 20Mbps, 100Mbps, 200Mbps, 1000Mbps or 2000Mbps after the negotiation with the connected device.

##### ■ Cabling

Each of the 10/100/1000BASE-T ports uses RJ45 sockets -- similar to the phone jacks -- for connection of unshielded twisted-pair cable (UTP). The IEEE 802.3/802.3u/802.3ab Fast/Gigabit Ethernet standard requires Category 5 UTP for 100Mbps 100BASE-TX. 10BASE-T networks can use Cat.3, 4, 5 or 1000BASE-T uses 5/5e/6 UTP (see table below). Maximum distance is 100 meters (328 feet).

Port Type	Cable Type	Connector
10BASE-T	Cat.3, 4, 5, 2-pair	RJ45
100BASE-TX	Cat.5, 5e UTP, 4-pair	RJ45
1000BASE-T	Cat.5/5e/6 UTP, 4-pair	RJ45

Any Ethernet devices like hubs/PCs can be connected to the GSD-1008HP by using straight-through wires. The whole 10/100/1000Mbps ports are auto-MDI/MDI-X that can be used on straight-through or crossover cable.

## 3.1 Desktop Installation

To install the GSD-1008HP on desktop, simply follow the following steps:

**Step 1:** Attach the rubber feet to the recessed areas on the bottom of the GSD-1008HP, as shown in Figure 3-1.

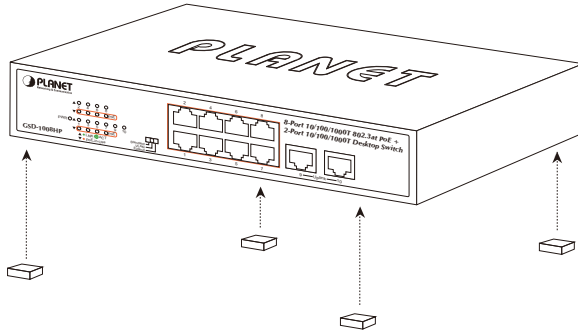

**Figure 3-1:** Attaching the Rubber Feet to the GSD-1008HP

**Step 2:** Place the GSD-1008HP on desktop near an AC power source.

**Step 3:** Keep enough ventilation space between the GSD-1008HP and the surrounding objects.



Note

When choosing a location, please keep in mind the environmental restrictions discussed in Chapter 1, Section 4, under Specifications.

**Step 4:** Connect your GSD-1008HP to 802.3af/at compliant power devices (PD) and other network devices.

- A.** Connect one end of a standard network cable to the 10/100/1000BASE-T RJ45 ports on the front panel of the GSD-1008HP.
- B.** Connect the other end of the cable to the network devices such as printer servers, workstations, routers, etc.



Note

Connection to the Switch requires UTP Category 5, 5e, 6 network cabling with RJ45 tips.

**Step 5:** Supply power to the GSD-1008HP.

**A.** Connect one end of the power cable to the GSD-1008HP.

**B.** Connect the power plug of the power cable to a standard wall outlet.

When the GSD-1008HP receives power, the Power LED should remain solid Green.

## 3.2 Rack Mounting

To install the GSD-1008HP in a 19-inch standard rack, follow the instructions described below.

**Step 1:** Place your GSD-1008HP on a hard flat surface, with the front panel positioned towards your front side.

**Step 2:** Attach a rack-mount bracket to each side of the GSD-1008HP with supplied screws attached to the package. Figure 3-2 shows how to attach brackets to one side of the GSD-1008HP.

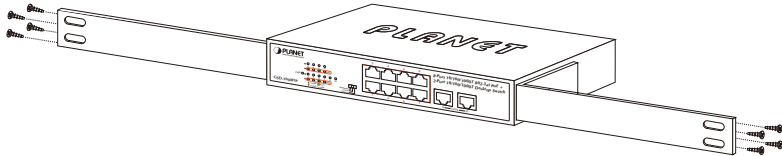

**Figure 3-2:** Attaching the Brackets to the GSD-1008HP.



You must use the screws supplied with the mounting brackets. Damage caused to the parts by using incorrect screws would invalidate the warranty.

**Step 3:** Secure the brackets tightly.

**Step 4:** Follow the same steps to attach the second bracket to the opposite side.

**Step 5:** After the brackets are attached to the GSD-1008HP, use suitable screws to securely attach the brackets to the rack, as shown in Figure 3-3.

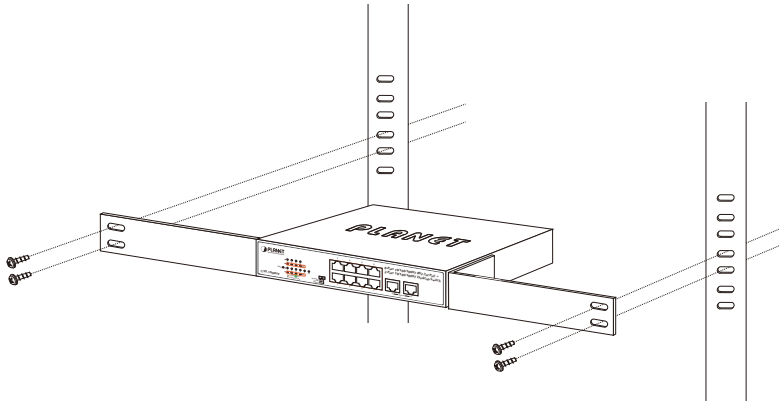

**Figure 3-3:** Mounting the GSD-1008HP in a Rack

**Step 6:** Proceed with Steps 4 and 5 of session 3.1 Desktop Installation to connect the network cabling and supply power to your Switch.

### 3.3 Wall Mounting Installation

**Step 1:** Please find the wall that can mount the GSD-1008HP.

**Step 2:** Install two screws on the wall.

**Step 3:** Hang the GSD-1008HP on the screws from the wall.

**Step 4:** Repeat step 5 of Desktop Installation for power supply to the GSD-1008HP.



Note

Before mounting the device to the wall, please check the location of the electrical outlet and the length of the Ethernet cable.

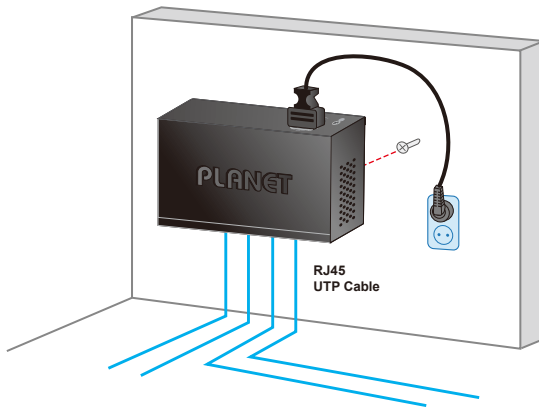
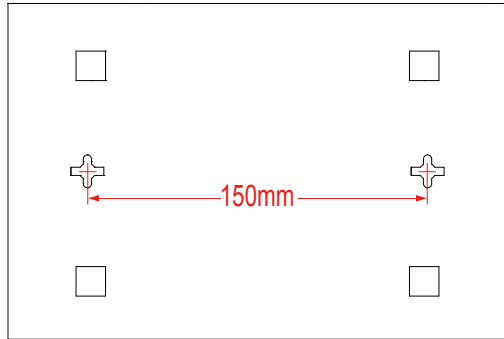



---

## 4. Troubleshooting

This chapter contains information to help you solve issues. If the GSD-1008HP is not functioning properly, make sure the GSD-1008HP was set up according to instructions in this manual.

### **Q1: The Link LED is not lit.**

#### **Solution:**

Check the cable connection and also try to swap one new cable.

### **Q2: 1000BASE-T port link LED is lit, but the traffic is irregular.**

#### **Solution:**

Make sure the attached device is not set to full duplex. Some devices use a physical or software switch to change duplex modes. Auto-negotiation may not recognize this type of full-duplex setting.

### **Q3: Why the Switch isn't connected to the network.**

#### **Solution:**

Check the LNK/ACT LED on the GSD-1008HP. Try another port on the GSD-1008HP. Make sure the cable is installed properly. Make sure the cable is the right type. Turn off the power. After a while, turn on the power again.

### **Q4: Why the GSD-1008HP, connected to PoE device, cannot be powered on.**

#### **Solution:**

Please check the cable type of the connection from the GSD-1008HP to the other end. The cable should be an 8-wire UTP, Category 5 or above and EIA568 cable within 100 meters. A cable with only 4-wire, short loop or over 100 meters will affect the power supply.

Please make sure the device is fully complied with IEEE 802.3af/IEEE 802.3at standard.

### **Q5: What is the power output of each PoE port?**

#### **Solution:**

1. Each PoE port supports 54-55V DC, 600mA and a maximum of 30 watts of power output. Detect and inject by the standard of IEEE 802.3at.
2. Each PoE port supports 54-55V DC, 300mA and a maximum of 15.4 watts of power output. Detect and inject by the standard of IEEE 802.3af.

## Appendix A - Networking Connection

### A.1 Switch's Data RJ45 Pin Assignments - 1000Mbps, 1000BASE-T

PIN NO	MDI	MDI-X
1	BI_DA+	BI_DB+
2	BI_DA-	BI_DB-
3	BI_DB+	BI_DA+
4	BI_DC+	BI_DD+
5	BI_DC-	BI_DD-
6	BI_DB-	BI_DA-
7	BI_DD+	BI_DC+
8	BI_DD-	BI_DC-

Implicit implementation of the crossover function within a twisted-pair cable, or at a wiring panel, while not expressly forbidden, is beyond the scope of this standard.

### A.2 10/100Mbps, 10/100BASE-TX

When connecting Switch to another Fast Ethernet switch, a straight-through or crossover cable might be necessary. Each port of the Switch supports auto-MDI/MDI-X detection, meaning you can directly connect the Switch to any Ethernet devices without making a crossover cable. The following table and diagram show the standard RJ45 receptacle/connector and their pin assignments:

RJ45 Connector Pin Assignment		
Contact	MDI Media Dependent Interface	MDI-X Media Dependent Interface-Cross
1	Tx + (transmit)	Rx + (receive)
2	Tx - (transmit)	Rx - (receive)
3	Rx + (receive)	Tx + (transmit)
4, 5	Not used	
6	Rx - (receive)	Tx - (transmit)
7, 8	Not used	

The standard cable, RJ45 pin assignment

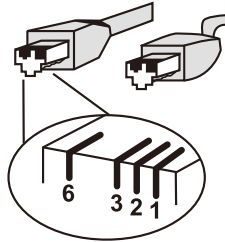

The standard RJ45 receptacle/connector

There are 8 wires on a standard UTP/STP cable and each wire is color-coded. The following shows the pin allocation and color of straight-through cable and crossover cable connection:

<u>Straight Cable</u>		<u>SIDE 1</u>	<u>SIDE 2</u>							
1	2	3	4	5	6	7	8	<u>SIDE 1</u>	1 = White/Orange	1 = White/Orange
2	3	4	5	6	7	8			2 = Orange	2 = Orange
3	4	5	6	7	8				3 = White/Green	3 = White/Green
4	5	6	7	8					4 = Blue	4 = Blue
5	6	7	8						5 = White/Blue	5 = White/Blue
6	7	8						<u>SIDE 2</u>	6 = Green	6 = Green
7	8								7 = White/Brown	7 = White/Brown
8									8 = Brown	8 = Brown

---

<u>Cross Over Cable</u>		<u>SIDE 1</u>	<u>SIDE 2</u>							
1	2	3	4	5	6	7	8	<u>SIDE 1</u>	1 = White/Orange	1 = White/Green
2	3	4	5	6	7	8			2 = Orange	2 = Green
3	4	5	6	7	8				3 = White/Green	3 = White/Orange
4	5	6	7	8					4 = Blue	4 = Blue
5	6	7	8						5 = White/Blue	5 = White/Blue
6	7	8						<u>SIDE 2</u>	6 = Green	6 = Orange
7	8								7 = White/Brown	7 = White/Brown
8									8 = Brown	8 = Brown

Figure A-1: Straight-through and Crossover Cable

Please make sure your connected cables are with the same pin assignment and color as the above description before deploying the cables into your network.

