



User Guide

Sound Bar

TRUE X BAR 40A

SR-X40A

EN

CONTENTS

| | |
|--|-----------|
| ABOUT THIS USER GUIDE | 5 |
| Information on the descriptions in this User Guide | 5 |
| INTRODUCTION | 6 |
| Features | 6 |
| Confirming the included items | 11 |
| PART NAMES AND FUNCTIONS | 13 |
| Part names of the sound bar (front/top) | 13 |
| Part names of the sound bar (rear) | 15 |
| Part names of the remote control | 16 |
| PREPARATION | 19 |
| Preparation | 19 |
| Precautions for preparation | 21 |
| Installing the product | 23 |
| Connecting to a TV | 25 |
| Jacks of TV to connect to and cables to use | 25 |
| Connecting to a TV using an HDMI cable (commercially available) | 27 |
| Connecting to a TV using only the included digital optical audio cable | 30 |
| Connecting an AV device | 31 |
| Connecting an AV device to the sound bar | 31 |
| Connecting an AV device to the TV's HDMI input jack | 33 |
| Connecting to power | 35 |
| Preparing the remote control | 36 |
| Turning on and off the sound bar | 37 |
| Connecting to a network | 38 |
| Network functions | 38 |
| Connecting to a network using a network cable (wired connection) | 39 |
| Connecting to a network wirelessly (wireless connection) | 40 |
| Connecting a subwoofer | 42 |

| | |
|--|-----------|
| Connecting wireless speakers | 43 |
| PLAYBACK | 44 |
| Basic control during playback | 44 |
| Adjusting the sound to your preference | 46 |
| Sound functions of this product | 46 |
| Surround playback | 48 |
| Stereo playback | 49 |
| Adjusting the volume of the subwoofer | 50 |
| Playing back human voices clearly (CLEAR VOICE) | 51 |
| Enjoying rich bass sound (BASS EXT) | 52 |
| Listening to audio from a Bluetooth® device | 53 |
| Playing music using Sound Bar Controller | 55 |
| Streaming services | 55 |
| Listening to audio with AirPlay 2 | 56 |
| ADDITIONAL FEATURES | 57 |
| Changing the brightness of the indicators | 57 |
| Using a TV's remote control to control the sound bar (HDMI Control) | 58 |
| Showing the type of audio signal and settings for functions | 59 |
| Controlling the sound bar with the smartphone app (Sound Bar Controller) | 61 |
| Controlling the sound bar by voice commands (Amazon Alexa) | 62 |
| CONFIGURATION | 64 |
| Enabling/disabling the HDMI Control function | 64 |
| Switching the HDMI audio output destination | 65 |
| Enabling/disabling the Auto Power Standby function | 66 |
| Enabling/disabling the Child Lock function | 67 |
| Enabling/disabling the network standby function | 68 |
| Enabling/disabling the Bluetooth function | 69 |
| Enabling/disabling the wireless (Wi-Fi) function | 70 |
| Setting the dynamic range compression level | 71 |
| Updating the firmware of this product | 73 |

Setting the HDMI signal format 74
Initializing the sound bar 75

TROUBLESHOOTING 76

Check the following first when any problem occurs 76
When a problem occurs: Power or overall functionality 77
When a problem occurs: Audio 87
When a problem occurs: Bluetooth® 93
When a problem occurs: Network 95
When a problem occurs: App 102
How to minimize standby power consumption 103
How to replace the remote control battery 104
How to reset the sound bar 107

SPECIFICATIONS 108

Specifications of this product 108
Supported HDMI video/audio signal formats 111
Supported digital audio signal formats 113
List of indicator displays 114

APPENDIX 117

Trademarks 117
List of support centers 119

ABOUT THIS USER GUIDE

Information on the descriptions in this User Guide

- This User Guide uses the following signal words for important information.



WARNING

This content indicates “risk of serious injury or death.”



CAUTION

This content indicates “risk of injury.”

NOTICE

Indicates points that you must observe in order to prevent product failure, damage or malfunction and data loss, as well as to protect the environment.

NOTE

Indicates notes on instructions, restrictions on functions, and additional information that may be helpful.

- The illustrations and screens in this User Guide are for instructional purposes only.
- The company names and product names in this User Guide are the trademarks or registered trademarks of their respective companies.
- Various smartphones and tablet devices are collectively referred to as “smartphones”. When necessary, the type of device is specified in the explanations.
- This User Guide mainly describes operations using the included remote control.
- A [Search tag] is a keyword for searching. This serves as a link from the Quick Start Guide to the User Guide.

NOTE

A Safety Brochure* and a Quick Start Guide are included with this product. See the Safety Brochure first.

* A Safety Brochure is not included with the model of this product for Mainland China. See the safety precautions on the back of the Quick Start Guide first.

INTRODUCTION

Features

This product is a bar-shaped speaker system for your TV that allows you to easily enjoy surround sound on the TV with a rich sense of presence.

By connecting the product to the Internet, audio playback from streaming services and use of the voice assistant “Amazon Alexa” are also available.

In addition, this product is compatible with “TRUE X SURROUND” that provides real surround sound using wireless speakers as surround speakers for the product.

■ Produce surround sound just by connecting to a TV

The “height speakers” built into the top of the sound bar which are designed exclusively to add a vertical dimension to the sound, together with “Dolby Atmos” object-based audio technology, allow for virtually reproducing sound not only from horizontal directions, but also from varying heights. This gives a vastness to the sound that seems to envelop your whole body, and enhances the feeling of being immersed in the worlds of movies, television, and music.



Related links

“Surround playback” (p.48)

■ Produce real surround sound using the TRUE X SURROUND function

The TRUE X SURROUND function provides real surround sound just by using TRUE X SURROUND compatible wireless speakers as surround speakers for the sound bar.

When playing audio in ALL mode of the TRUE X SURROUND function, the same audio is output from the sound bar and from the wireless speakers. This mode is useful for playing audio as background music in a large room.

For details, see the following TRUE X SURROUND Connection and Operation Guide.

<https://manual.yamaha.com/av/truexsur/>



■ Easily play audio content from streaming services or a Bluetooth device

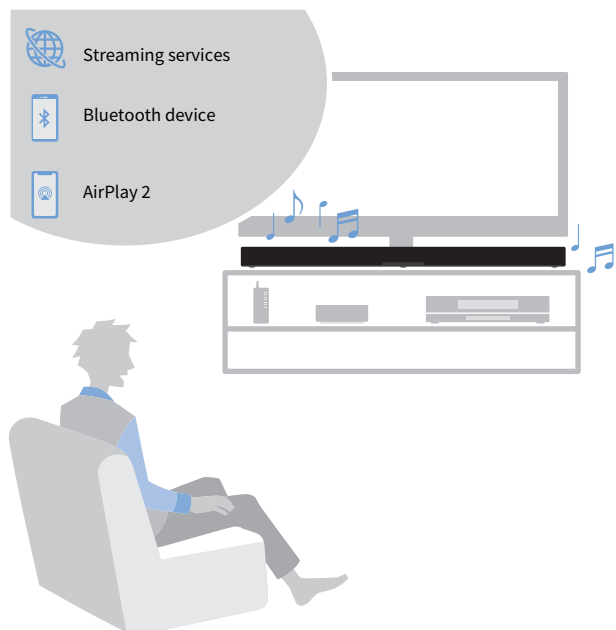

Related links

- “Streaming services” (p.55)
- “Listening to audio from a Bluetooth® device” (p.53)
- “Listening to audio with AirPlay 2” (p.56)

■ Amazon Alexa built-in

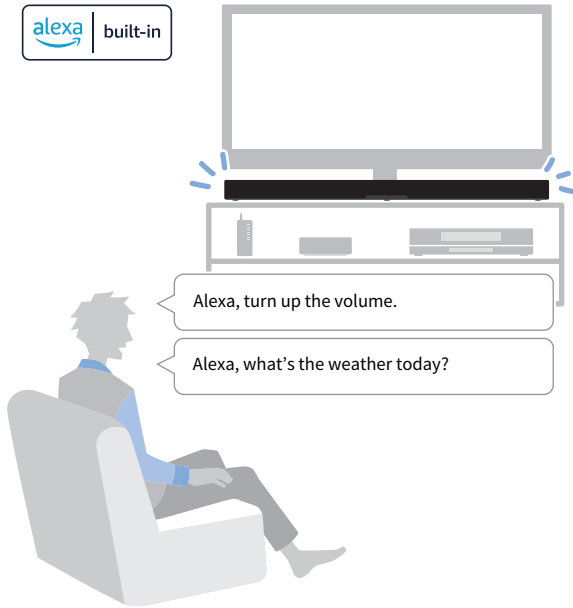

Related links

“Controlling the sound bar by voice commands (Amazon Alexa)” (p.62)

■ Configure the sound to match the situation

Clear Voice

This function focuses on the acoustic image of human voices such as dialog and narration within the audio and emphasizes the voices without changing the overall volume or individuality of the sound. Only the human voices become easier to hear, and it gives a clear sense of localization to the human voices.

- “Playing back human voices clearly (CLEAR VOICE)” (p.51)

Bass Extension

This function focuses on the acoustic image of the bass portion and enhances bass sound. It allows you to enjoy rich bass performance with a strong presence by adjusting the overall acoustic image of bass sound to clarify without disturbing the balance of the overall sound.

- “Enjoying rich bass sound (BASS EXT)” (p.52)

■ **Multiple control methods to suit various usage situations**

In addition to the sound bar's controls and the included remote control, the TV's remote control, the dedicated smartphone app "Sound Bar Controller", or Amazon Alexa can also be used to control the sound bar.

Audio Return Channel (eARC/ARC) and HDMI Control function

An HDMI control function compatible TV allows for controlling the sound bar's basic functions using the TV's remote control. An Audio Return Channel (eARC/ARC) compatible TV can be connected to the sound bar using a single HDMI cable.

- "Connecting to a TV using an HDMI cable (commercially available)" (p.27)
- "Using a TV's remote control to control the sound bar (HDMI Control)" (p.58)

Dedicated smartphone app: "Sound Bar Controller"

This app is used to configure settings to connect the sound bar to a network. In addition, it allows you to control the sound bar using your smartphone or play audio files stored in your smartphone.

- "Connecting to a network wirelessly (wireless connection)" (p.40)
- "Controlling the sound bar with the smartphone app (Sound Bar Controller)" (p.61)

Confirming the included items

The following items are included with this product. Make sure that all of the included items are present.

■ Main devices

- Sound bar (SR-X40A)



■ Accessories

- Remote control



* A Lithium battery (CR2025) has already been inserted into the remote control.

- Power cord



- Digital optical audio cable



- Spacers (×2)



* Use when mounting the sound bar on a wall.

- Mounting template



* Use when mounting the sound bar on a wall.

INTRODUCTION > Confirming the included items

- Quick Start Guide



- Safety Brochure



NOTE

An HDMI cable is not included. If you intend to use an HDMI cable to connect this product, get one that is commercially available. Choose an HDMI cable according to the functions of the device to be connected.

PART NAMES AND FUNCTIONS

Part names of the sound bar (front/top)

This section describes the part names and functions of the front and top of the sound bar.

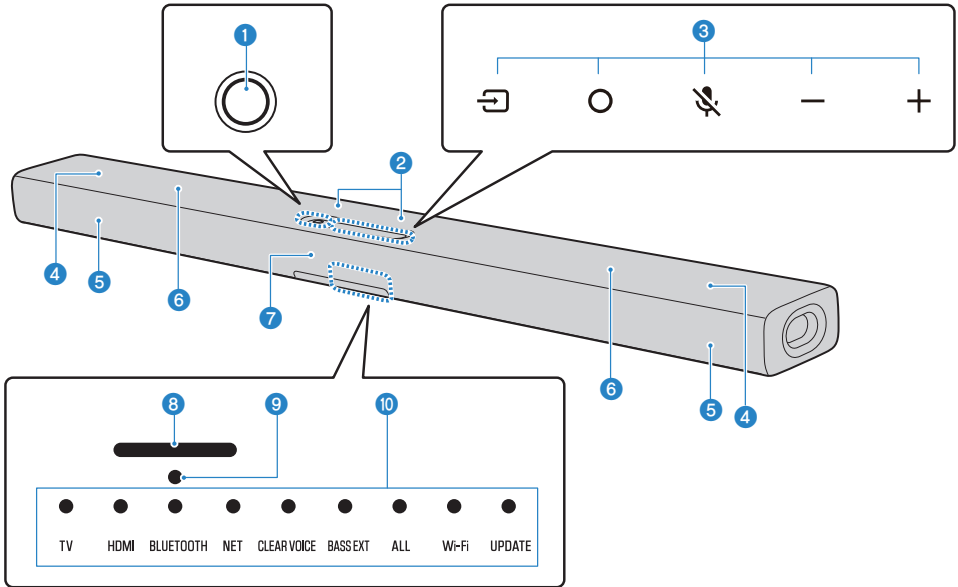

1 Power button

Turn the sound bar on and off.

2 Microphones

Use when interacting with Alexa.

NOTICE

- Do not use a vacuum cleaner or air duster on the microphone area when cleaning the sound bar. Doing so may damage the microphones.

3 Controls

Use to control the sound bar.

⏮ (Input): Select an input source (p.44).

○ (Action): Wake Alexa (p.62).

🎤 (Microphones on/off): Turn the microphones on and off. Alexa does not respond while the microphones are turned off, even if Alexa is called. Disable the microphones when you want to maintain privacy. The microphones are turned on when the symbol is pressed again (p.62).

-/+ (Volume -/+): Adjust the volume (p.44).

4 **Height speakers**

5 **Front speakers**

6 **Built-in subwoofers**

7 **Remote control sensor**

8 **Alexa Indicator**

Indicates the status of Alexa.

9 **Microphones Off Indicator**

Glow red when the microphones for interacting with Alexa are turned off.

10 **Indicators**

The indicators on the top panel flash or glow to show the operation and setting status. During normal playback, the setting status is indicated as follows:

TV/HDMI / BLUETOOTH / NET: Selected input source

CLEAR VOICE: Clear Voice

BASS EXT: Bass Extension

ALL: ALL mode

Wi-Fi: Wi-Fi connecting

UPDATE: Firmware update

NOTE

This User Guide uses the following illustrations to show that indicators are off, glowing, or flashing.



Off



Glowing



Flashing

NOTE

- To prevent unintended operation, do not place anything on the controls of the sound bar. Enabling the Child Lock function prevents accidental operation.
- The brightness of the indicators can be adjusted by pressing  (Brightness) on the remote control.
- For details on the ALL mode, see the following TRUE X SURROUND Connection and Operation Guide. <https://manual.yamaha.com/av/truexsur/>

Related links

- “Enabling/disabling the Child Lock function” (p.67)
- “Changing the brightness of the indicators” (p.57)

Part names of the sound bar (rear)

This section describes the part names and functions of the rear of the sound bar.

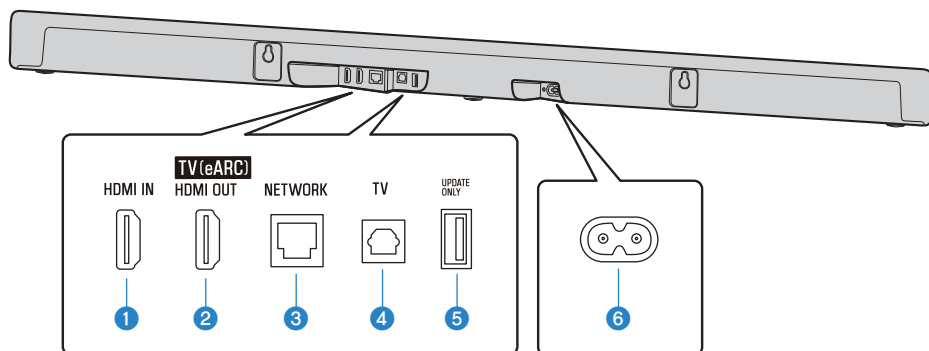

1 **HDMI IN jack** (p.31)

2 **HDMI OUT/TV (eARC) jack** (p.27)

3 **NETWORK jack** (p.39)

4 **TV input jack** (p.25)

5 **UPDATE ONLY jack**

Use to update the sound bar's firmware.

For details, see the following Firmware Update Guide.

https://manual.yamaha.com/av/fwupdate/21/sr_ws/

6 **AC power input jack**

Related links

- "Part names of the sound bar (front/top)" (p.13)
- "Part names of the remote control" (p.16)

Part names of the remote control

This section describes the part names and functions of the remote control.

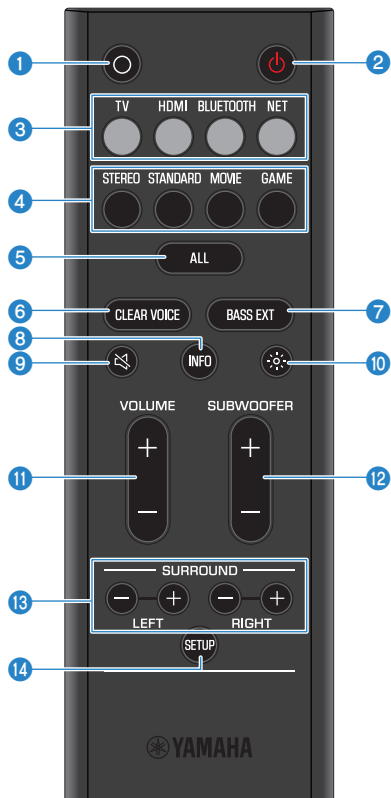

1 ○ (Action) button

Wake Alexa (p.62).

2 ⏻ (Power) button

Turn the sound bar on and off (p.37).

3 Input source buttons

Select an audio input source (p.44).

- TV button: Audio from a TV
- HDMI button: Audio from a device connected to the HDMI input jack
- BLUETOOTH button: Audio from a Bluetooth device
- NET button: Audio from streaming services

4 Sound mode buttons

Switch to your preferred sound mode (p.46).

- STEREO
- STANDARD
- MOVIE
- GAME

5 ALL button

Enable or disable the ALL mode.

For details, see the following TRUE X SURROUND Connection and Operation Guide.

<https://manual.yamaha.com/av/truexsur/>

6 CLEAR VOICE button

Enable or disable the Clear Voice function (p.51).

7 BASS EXT button

Enable or disable the Bass Extension function (p.52).

8 INFO button

Check information such as the type of audio signal being played and the settings for the sound bar's functions (p.59).

9  (Mute) button

Mute the audio output (p.44). Press this button again, or press VOLUME (+/-) to unmute.

10  (Brightness) button

Switch the brightness of the indicators of the sound bar (p.57).

11 VOLUME (+/-) button

Adjust the volume of the sound bar (p.44).

12 SUBWOOFER (+/-) button

Adjust the volume of the subwoofer (p.50).

13 SURROUND L/R (+/-) buttons

Adjust the volume of each surround speaker when wireless speakers are used as surround speakers for the sound bar.

For details, see the following TRUE X SURROUND Connection and Operation Guide.

<https://manual.yamaha.com/av/truexsur/>

14 SETUP button

- Used when connecting to the TRUE X SUB 100A (SW-X100A) dedicated subwoofer (sold separately) (p.42).
- Used when registering wireless speakers compatible with TRUE X SURROUND (sold separately) as surround speakers (p.43).

NOTE

Use the remote control within the range shown in the following illustration:

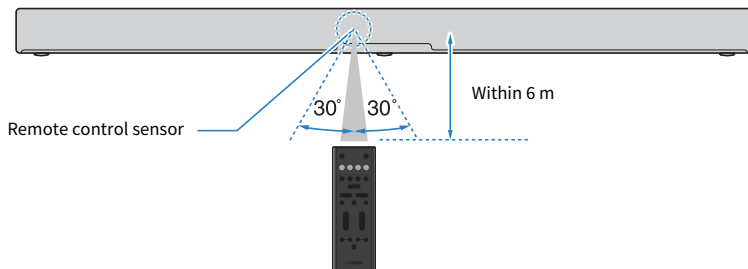

Related links

“Part names of the sound bar (front/top)” (p.13)

PREPARATION

Preparation

To play audio on this product, do the following preparations:

1 Install the sound bar.

“Installing the product” (p.23)

2 Connect the sound bar to a TV.

Connect the sound bar to the TV using a method suitable for the type of jacks on the TV and the functions to be used.

“Jacks of TV to connect to and cables to use” (p.25)

“Connecting to a TV using only the included digital optical audio cable” (p.30)

“Connecting to a TV using an HDMI cable (commercially available)” (p.27)

3 Connect an AV device (if required).

“Connecting an AV device to the sound bar” (p.31)

“Connecting an AV device to the TV’s HDMI input jack” (p.33)

4 Connect to power.

“Connecting to power” (p.35)

5 Prepare the remote control.

“Preparing the remote control” (p.36)

6 Turn on the sound bar.

“Turning on and off the sound bar” (p.37)

7 Connect to a network (if required).

“Network functions” (p.38)

“Connecting to a network using a network cable (wired connection)” (p.39)

“Connecting to a network wirelessly (wireless connection)” (p.40)

8 Connect an external subwoofer (if required).

“Connecting a subwoofer” (p.42)

9 Connect wireless speakers (if required).

“Connecting wireless speakers” (p.43)

For details, see the following TRUE X SURROUND Connection and Operation Guide.

<https://manual.yamaha.com/av/truexsur/>

Precautions for preparation

Before installing the sound bar and connecting other devices, be sure to read the following precautions. Be sure to follow the precautions.

■ Precautions for installation



WARNING

- Install as instructed in the User Guide. Failure to observe this may cause devices to fall and result in injury.
- Confirm that the finished installation is safe and secure. Also, carry out safety inspections periodically. Failure to observe this may cause devices to fall and result in injury.
- Do not expose the product to rain, use it near water or in damp or wet conditions, or place on the product any containers (such as vases, bottles or glasses) containing liquids which might spill into any openings or places where water may drop. A liquid such as water getting into the product may cause a fire, electric shocks, or malfunctions.
- Do not place any burning items or open flames near the product, since they may cause a fire.
- Do not use this product near medical devices or inside medical facilities. Radio waves from this product may affect electro-medical devices.



CAUTION

- Do not place the product in an unstable position where it might accidentally drop or fall over and cause injuries.
- When installing this product, do not obstruct heat dissipation. Failure to observe this may trap heat inside the product, causing a fire or malfunctions.
- Avoid being near the product during a disaster, such as an earthquake. Since the product may turn over or fall and cause injury, quickly move away from the product and go to a safe place.

NOTICE

- Do not install the product in places where it may come into contact with corrosive gases or salt air, or places that have excessive smoke or steam. Doing so may result in malfunction.
- Do not press hard on the speaker units or fabric-covered portion of this product.
- Do not place any objects susceptible to magnetism (such as a hard disk drive or magnetic card) near the product. The magnetic effect of the sound bar may cause damage to the object or its recorded data.
- Do not use this product in a location that becomes extremely hot, such as in direct sunlight or near a heater, or that becomes extremely cold, or that is subject to excessive dust or vibration. Failure to observe this may cause this product's panel to become deformed, the internal components to malfunction, or for operation to become unstable.
- If using a wireless function, avoid installing this product near metal walls or desks, microwave ovens, or other wireless network devices. Obstructions could shorten the transmission distance.

■ Precautions for connections



WARNING

- Use this product with the power supply voltage printed on it. Failure to observe this may cause a fire, electric shocks, or malfunctions.
- Be sure to use the supplied power cord. Do not use the supplied power cord for other devices. Failure to observe this may cause a fire, electric shocks, or malfunctions.
- Never insert or remove an electric plug with wet hands. Do not handle this product with wet hands. Failure to observe this may cause electric shocks or malfunctions.
- Do not touch the power plug or cord if there is a chance of lightning. Failure to observe this may cause electric shocks.
- When setting up the product, make sure that the AC outlet you are using is easily accessible. If some trouble or malfunction occurs, immediately turn off the power switch and disconnect the plug from the AC outlet. Even when the power switch is turned off, as long as the power cord is not unplugged from the wall AC outlet, the product will not be disconnected from the power source.
- If not using the product for long periods of time, be sure to pull the power plug from the AC outlet. Failure to observe this may cause a fire or malfunctions.
- Check the electric plug periodically and remove any dirt or dust which may have accumulated on it. Failure to observe this may cause a fire or electric shocks.



CAUTION

- Do not use an AC outlet where the power plug fits loosely when inserted. Failure to observe this may cause a fire, electric shocks, or burns.
- When disconnecting the power plug, always hold the plug itself and not the cord. Pulling by the cord can damage it and cause electric shocks or a fire.
- Insert the power plug firmly all the way into the AC outlet. Using the product when it is not plugged in sufficiently can cause dust to accumulate on the plug, causing a fire or burns.

NOTICE

- If connecting external devices, be sure to thoroughly read the User Guide for each device and connect them in accordance with the instructions. Failure to properly handle a device in accordance with the instructions could cause malfunctions.
- Do not connect this product to industrial devices. This product has been designed to connect to consumer-use devices. Connection to an industrial-use device could cause this product to malfunction.

Installing the product

- Before installing the sound bar, be sure to read the following precautions.
 - “Precautions for preparation” (p.21)

Install the sound bar as shown in the following illustration.

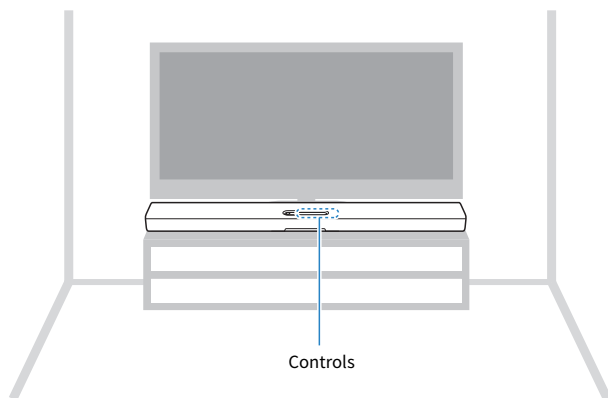

NOTICE

- Leave a space of at least 10 cm (4 in) above, 10 cm (4 in) to the left and right, and 10 cm (4 in) behind the sound bar to allow heat dissipation.
- The top of the sound bar is equipped with built-in height speakers that output the sound of the height channels. A space of at least 10 cm (4 in) above the top of the sound bar ensures unobstructed output of the height channels. This will provide you the best possible surround sound field.

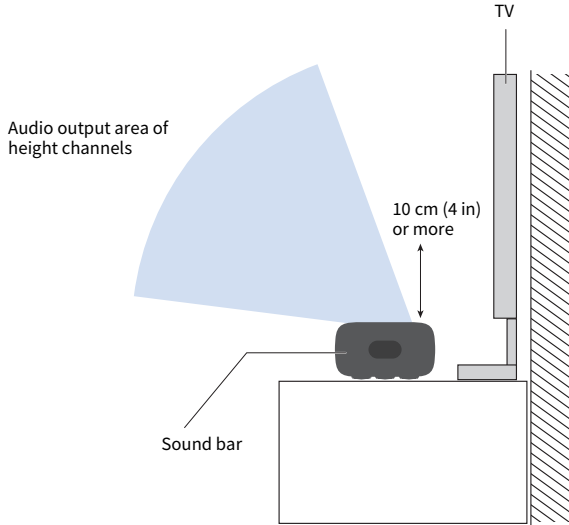

NOTE

The sound bar can also be mounted on a wall. For proper installation of the sound bar on a wall, make sure to have the work done by the dealer from where you purchased the unit or by a contractor with qualified service personnel. For more information, visit the following website.

https://manual.yamaha.com/av/sb/wallmount/srx40a_x50a/

Next steps

- Connecting to a TV:
 - “Jacks of TV to connect to and cables to use” (p.25)
 - “Connecting to a TV using an HDMI cable (commercially available)” (p.27)
 - “Connecting to a TV using only the included digital optical audio cable” (p.30)

Connecting to a TV

Jacks of TV to connect to and cables to use

In order to fully use the functions of the sound bar, connect the TV and the sound bar with an HDMI cable.

An HDMI cable is not included with this product. Prepare a commercially available HDMI cable that is compatible with the functions of the device to connect to. (See below.)

When connecting to an HDMI input jack not compatible with ARC, also connect the included digital optical audio cable.

Cable(s) to use

HDMI cable (commercially available)

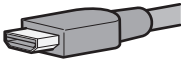

When connecting to an HDMI input jack not compatible with ARC:

Digital optical audio cable (included)

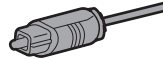

Jack(s) of TV to connect to

HDMI input jack



When connecting to an HDMI input jack not compatible with ARC:

Digital optical audio output jack



Connection procedure

“Connecting to a TV using an HDMI cable (commercially available)” (p.27)

■ Functions of the device to connect to and compatible HDMI cables

Connect the TV and sound bar using an HDMI cable that is compatible with the functions you want to use.

Using a TV's remote control to control the sound bar (HDMI Control function)

An HDMI cable of “Standard HDMI” specification or higher can be used. Use an ARC-compatible HDMI cable if the HDMI input jack of the TV supports ARC.

Inputting high-definition audio signals such as Dolby Atmos from an eARC-compatible TV to the sound bar

Use an Ethernet-supporting HDMI cable.

Transmitting high-definition video signals to the TV from an AV device connected to the HDMI IN jack on the sound bar

Use an HDMI cable that supports the transmission of video signals output from the AV device.

- For 3D and/or 4K video signals, use a Premium High Speed HDMI cable.
- For HDR video signals, use an HDR-compatible HDMI cable.

■ If connecting to a TV using only the included digital optical audio cable

If the TV is equipped with a digital optical jack, the TV can be connected using only the included digital optical audio cable. Use the included remote control to control the sound bar.

Cable: Digital optical audio cable (included)

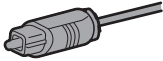

Jack of TV to connect to: Digital optical audio output jack



Connection procedure

“Connecting to a TV using only the included digital optical audio cable” (p.30)

NOTE

- ARC is an abbreviation for Audio Return Channel. By connecting the ARC-compatible HDMI input jack on the TV to the ARC-compatible HDMI output jack on the sound bar or an AV receiver via an HDMI cable, audio from the TV can be played on the sound bar or AV receiver without using an optical cable.
- eARC is an abbreviation for Enhanced Audio Return Channel. It is an extension of the ARC functionality and is capable of transmitting high-definition audio signals such as Dolby Atmos via a TV, which ARC cannot transmit.
- Use a 19-pin HDMI cable with the HDMI logo printed on it.
- Use a cable that is as short as possible to prevent any degradation in signal quality.

Connecting to a TV using an HDMI cable (commercially available)

- Before connecting devices, be sure to read the following precautions.
 - “Precautions for preparation” (p.21)

If a TV is connected via an HDMI cable, the sound bar can be controlled by the HDMI Control function using the TV’s remote control.

■ When connecting to an HDMI input jack that is compatible with Audio Return Channel (eARC/ARC)

Connect to the TV using an ARC-compatible HDMI cable (commercially available).

Connect an HDMI cable to an HDMI input jack compatible with Audio Return Channel (labeled as “eARC” or “ARC”) on the TV.

The HDMI cable transmits the TV’s audio signal and the control signal for controlling the sound bar using the TV’s remote control. In addition, it transmits video signals to the TV from an AV device connected to the HDMI IN jack on the sound bar.

- If the sound bar is connected to an eARC-compatible HDMI input jack on the TV, high-definition audio signals such as Dolby Atmos can be transmitted to the sound bar. If connecting to an eARC-compatible HDMI input jack on the TV, use an Ethernet-supporting HDMI cable. When connecting to an HDMI input jack that is compatible only with ARC on the TV, use an ARC-compatible HDMI cable.

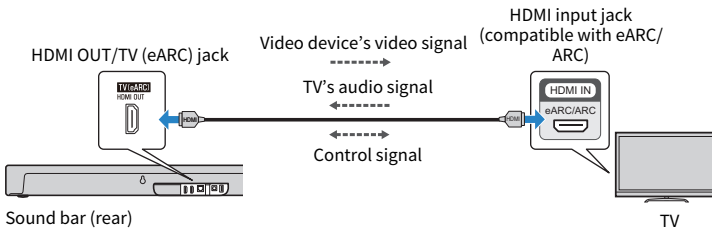

Cable to use



HDMI cable (commercially available)

■ When connecting to an HDMI input jack not compatible with ARC

Connect to the TV using an HDMI cable (commercially available) and the included digital optical audio cable.



The digital optical audio cable transmits the TV’s audio signal to the sound bar.

The HDMI cable transmits the control signal for controlling the sound bar using the TV’s remote control (HDMI Control function). In addition, it transmits video signals to the TV from an AV device connected to the HDMI IN jack on the sound bar.

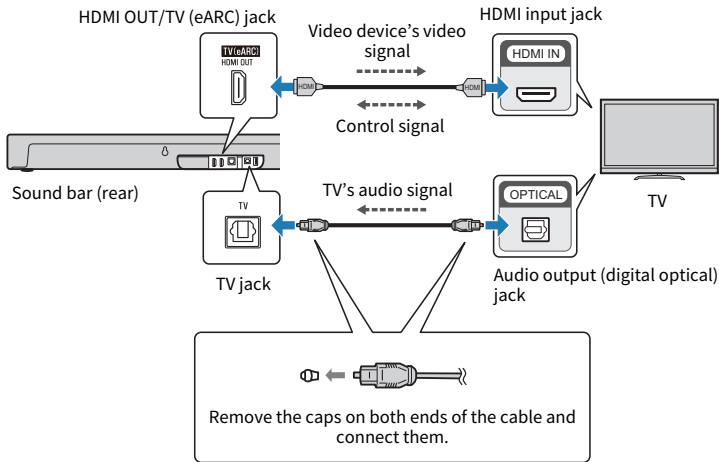
PREPARATION > Connecting to a TV



Cable to use

-  Digital optical audio cable (included)
-  HDMI cable (commercially available)

NOTE

- ARC is an abbreviation for Audio Return Channel. By connecting the ARC-compatible HDMI input jack on the TV to the ARC-compatible HDMI output jack on the sound bar or an AV receiver via an HDMI cable, audio from the TV can be played on the sound bar or AV receiver without using an optical cable.
- eARC is an abbreviation for Enhanced Audio Return Channel. It is an extension of the ARC functionality and is capable of transmitting high-definition audio signals such as Dolby Atmos via a TV, which ARC cannot transmit.
- When using the ARC function or the HDMI Control function, enable the HDMI Control function of the sound bar. Default setting: Enabled
- Use a 19-pin HDMI cable with the HDMI logo printed on it.
- Use a cable that is as short as possible to prevent any degradation in signal quality.
- When connecting an AV device to the HDMI IN jack on the sound bar, to connect the TV and sound bar, use an HDMI cable that supports the transmission of video signals output from that AV device.
 - For 3D and/or 4K video signals, use a Premium High Speed HDMI cable.
 - For HDR video signals, use an HDR-compatible HDMI cable.

Next steps

- If connecting an AV device:
 - “Connecting an AV device to the sound bar” (p.31)
 - “Connecting an AV device to the TV’s HDMI input jack” (p.33)
- If not connecting an AV device:
 - “Connecting to power” (p.35)

PREPARATION > Connecting to a TV

Related links

[“Enabling/disabling the HDMI Control function” \(p.64\)](#)

Connecting to a TV using only the included digital optical audio cable

- Before connecting devices, be sure to read the following precautions.
 - “Precautions for preparation” (p.21)

Connect to a TV using the included digital optical audio cable.

The digital optical audio cable transmits the TV's audio signal to the sound bar.

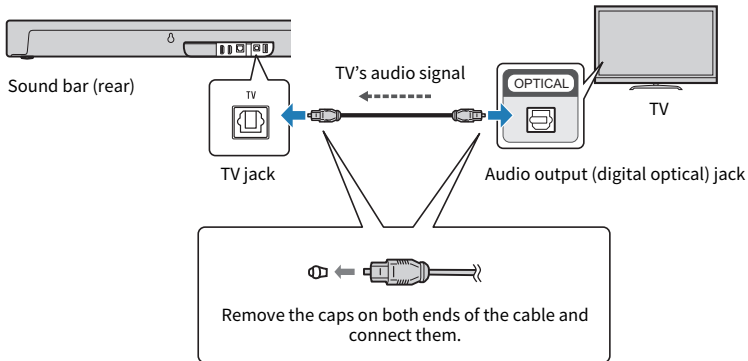

Cable to use



Digital optical audio cable (included)

Next steps

- “Connecting to power” (p.35)

Connecting an AV device

Connecting an AV device to the sound bar

- Before connecting devices, be sure to read the following precautions.
 - “Precautions for preparation” (p.21)

Connect AV devices (such as BD/DVD players and set top boxes) to the sound bar using an HDMI cable (commercially available).

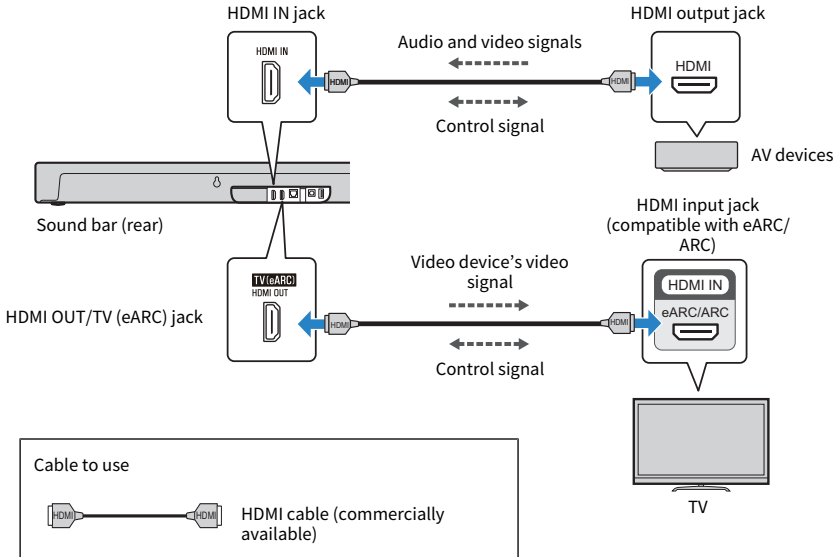

NOTE

- To play audio from an AV device via the sound bar, set the input sources as follows:
 - Sound bar's input source: HDMI
- Once the HDMI control function has been activated on the sound bar, video and audio content from AV devices can be output from the TV even when the sound bar is off (HDMI signal pass-through). Default setting: Enabled
- Use a 19-pin HDMI cable with the HDMI logo printed on it.
- Use a cable that is as short as possible to prevent any degradation in signal quality.
- For connecting the sound bar and TV, and for connecting the sound bar and AV device, use HDMI cables that support the transmission of video signals output from the AV device.
 - For 3D and/or 4K video signals, use a Premium High Speed HDMI cable.
 - For HDR video signals, use an HDR-compatible HDMI cable.

Next steps

- “Connecting to power” (p.35)

Related links

[“Enabling/disabling the HDMI Control function” \(p.64\)](#)

Connecting an AV device to the TV's HDMI input jack

- Before connecting devices, be sure to read the following precautions.
 - "Precautions for preparation" (p.21)

Connect AV devices (such as BD/DVD players and set top boxes) to the TV using an HDMI cable (commercially available). To connect multiple AV devices or switch AV devices for playback using the TV's input selector, use this connection method.

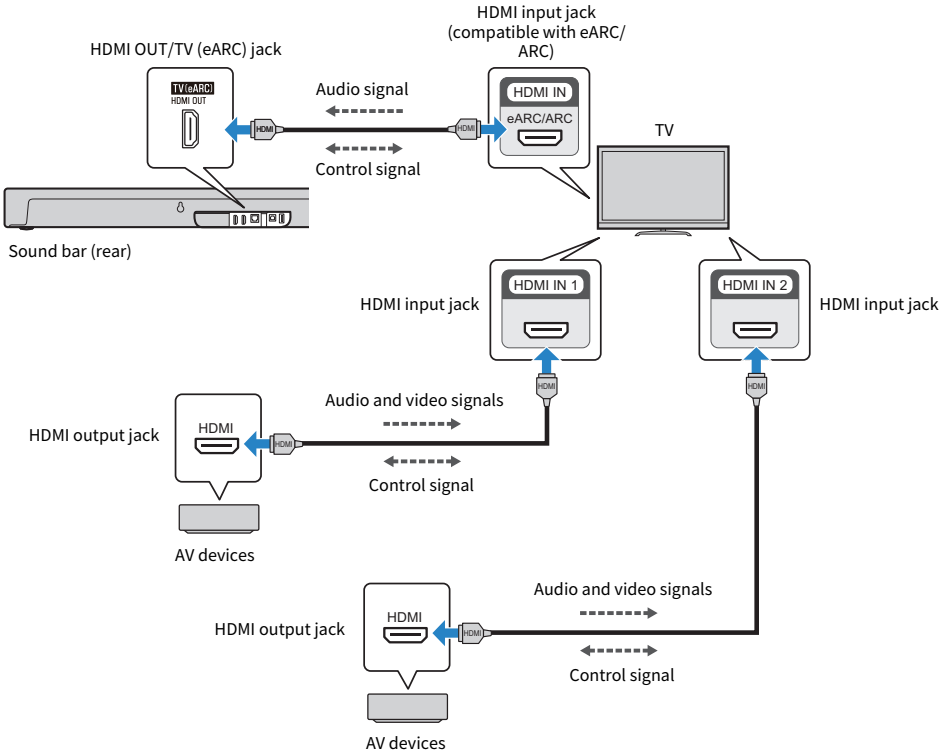

Cable to use

 HDMI cable (commercially available)

NOTE

- To play audio from an AV device via the sound bar, set the input sources as follows:
 - Sound bar's input source: TV
 - TV's input source: AV device playing the content
- ARC is an abbreviation for Audio Return Channel. By connecting the ARC-compatible HDMI input jack on the TV to the ARC-compatible HDMI output jack on the sound bar or an AV receiver via an HDMI cable, audio from the TV can be played on the sound bar or AV receiver without using an optical cable.
- eARC is an abbreviation for Enhanced Audio Return Channel. It is an extension of the ARC functionality and is capable of transmitting high-definition audio signals such as Dolby Atmos via a TV, which ARC cannot transmit.
- When the sound bar is connected to an ARC-compatible HDMI input jack on the TV, enable the HDMI Control function of the sound bar. Default setting: Enabled
- Use a 19-pin HDMI cable with the HDMI logo printed on it.
- Use a cable that is as short as possible to prevent any degradation in signal quality.
- To use the eARC or ARC function, use an eARC/ARC-compatible HDMI cable such as an Ethernet-supporting High Speed HDMI cable.
- For connecting the TV and AV device, use an HDMI cable that supports the transmission of video signals output from the AV device.
 - For 3D and/or 4K video signals, use a Premium High Speed HDMI.
 - For HDR video signals, use an HDR-compatible HDMI cable.
- Depending on your TV, the high-definition audio signals (Dolby Atmos, etc.) input from the AV device may be converted to other audio signals and transmitted. In order to reproduce sound that makes the most of the characteristics of the audio signals output from the AV device, connect it to the sound bar's HDMI IN jack.

Next steps

- "Connecting to power" (p.35)

Related links

"Enabling/disabling the HDMI Control function" (p.64)

Connecting to power

After connecting to the TV and AV devices, connect the sound bar to power.

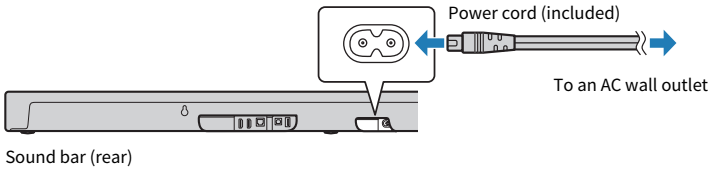

After connecting the power, some of the indicators on the front of the sound bar flash for approximately one minute as follows, and then turn off.



Make sure that the indicators are turned off before turning on the sound bar.

Next steps

- "Preparing the remote control" (p.36)

Related links

"Turning on and off the sound bar" (p.37)

Preparing the remote control

Remove the battery insulating strip before attempting to use the remote control.

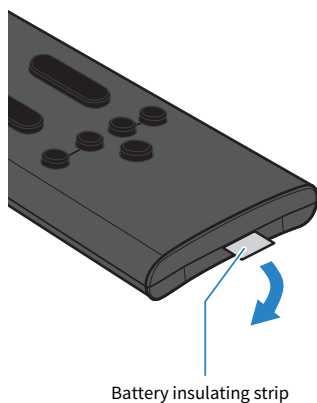

Related links

[“Replacing the remote control battery” \(p.105\)](#)

Turning on and off the sound bar

Turn the sound bar on and off.

1 Press the (Power) button on the remote control.

Pressing the button turns the sound bar on and off.

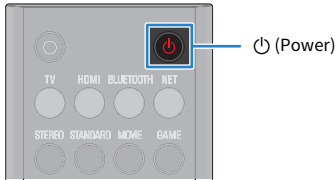

When the sound bar is turned on, all the indicators on the front of the sound bar glow, and then some indicators remain glowing to show the setting status (normal display).

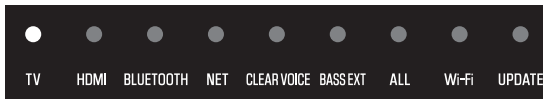

When the sound bar is turned off, the indicators go off.

NOTE

After connecting the power, some of the indicators on the front of the sound bar flash for approximately one minute as follows, and then turn off.

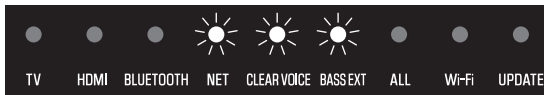

Make sure that the indicators turn off before turning on the sound bar.

Next steps (if needed)

- Connecting the sound bar to a network:
 - “Network functions” (p.38)
 - “Connecting to a network using a network cable (wired connection)” (p.39)
 - “Connecting to a network wirelessly (wireless connection)” (p.40)
- Connecting the SW-X100A subwoofer (sold separately):
 - “Connecting a subwoofer” (p.42)
- Connecting the WS-X3A/WS-X2A/WS-X1A wireless speakers (sold separately):
 - “Connecting wireless speakers” (p.43)

Connecting to a network

Network functions

If the sound bar is connected to a network, the following network-based functions are available.

- Various streaming services
- Amazon Alexa
- Playback with AirPlay
- Controlling the sound bar with the app

The sound bar supports wired and wireless connections. Connect the sound bar to a network with the wired or wireless connection method based on your network environment.

- “Connecting to a network using a network cable (wired connection)” (p.39)
- “Connecting to a network wirelessly (wireless connection)” (p.40)

NOTICE

- Do not connect this product to a public Wi-Fi and/or Internet service directly. Only connect this product to the Internet through a router with strong password protections. Consult your router manufacturer for information on optimum security practices.

NOTE

- The sound bar cannot be connected to a network that requires manual setup. Connect the sound bar to a DHCP-enabled router.
- The dedicated smartphone app “Sound Bar Controller” is required to configure the wireless connection settings.
- Amazon Alexa and streaming services are only provided in certain areas. Amazon Alexa and streaming services may not be available in some countries or regions where the product is used.

Related links

- “Streaming services” (p.55)
- “Controlling the sound bar by voice commands (Amazon Alexa)” (p.62)

Connecting to a network using a network cable (wired connection)

Connect the sound bar to a router using a commercially available LAN cable (a CAT-5 or higher STP straight cable). The wired connection is now complete.

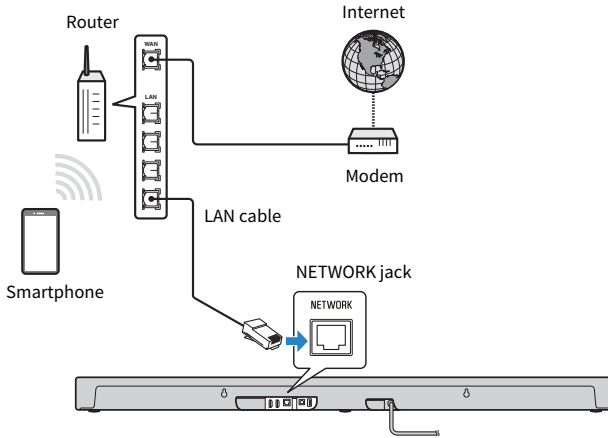

NOTICE

- Do not connect this product to a public Wi-Fi and/or Internet service directly. Only connect this product to the Internet through a router with strong password protections. Consult your router manufacturer for information on optimum security practices.

Connecting to a network wirelessly (wireless connection)

Connect to a wireless LAN router (an access point) to use a network. Configure wireless connection settings using the dedicated smartphone app “Sound Bar Controller.”

[Search tag]#Q02 Network

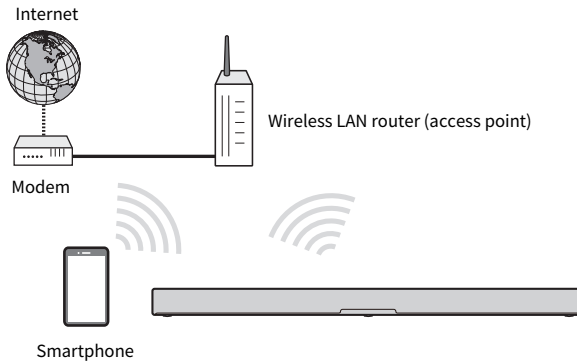

NOTICE

- Do not connect this product to a public Wi-Fi and/or Internet service directly. Only connect this product to the Internet through a router with strong password protections. Consult your router manufacturer for information on optimum security practices.

NOTE

- The sound bar cannot be connected to a wireless LAN router (an access point) if they are far apart. In such a case, install the sound bar and wireless LAN router (access point) close to each other.
- Confirm that your smartphone is connected to your home router before operation.
- The display may differ from the example depending on the smartphone that is being used.
- Screens and menu names of the Sound Bar Controller app are subject to change without prior notice.

1 Install the Sound Bar Controller app on your smartphone and open the app.

Search for “Sound Bar Controller” on the App Store or Google Play and install it on the mobile device.

2 Follow the app screen instructions to configure.

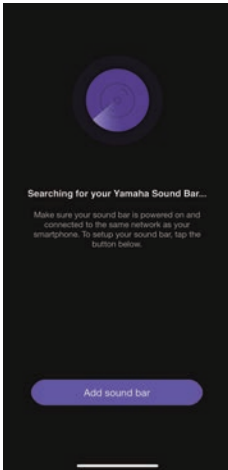

When connected to a wireless network, the Wi-Fi indicator on the sound bar glows.



When the sound bar is connected to a network for the first time after purchase, its firmware is updated to the latest version.

Once the network connection settings have been configured, configure Amazon Alexa. Follow the app screen instructions to configure. It can also be configured later in “Amazon Alexa Settings” in the app.

Related links

- “Controlling the sound bar with the smartphone app (Sound Bar Controller)” (p.61)
- “Controlling the sound bar by voice commands (Amazon Alexa)” (p.62)

Connecting a subwoofer

By connecting the TRUE X SUB 100A (SW-X100A) dedicated subwoofer (sold separately), you can enjoy deeper sound.

NOTE

See also the SW-X100A Owner's Manual for details on how to operate SW-X100A.

1 Install a subwoofer in the room and connect the power cord of the subwoofer to an AC wall outlet.

The CONNECT indicator on the subwoofer is flashing rapidly.



If the CONNECT indicator is flashing slowly, hold down SETUP on the rear of the subwoofer for at least five seconds.



SETUP

2 Turn on the sound bar.

3 Hold down SETUP on the sound bar's remote control for at least five seconds.



When the connection is established, the CONNECT indicator on the rear of the subwoofer glows.



NOTE

- The volume of the connected subwoofer can be adjusted with SUBWOOFER (+/-) on the sound bar's remote control.
- Press INFO on the sound bar's remote control to check the connection status of the subwoofer.

Related links

"Showing the type of audio signal and settings for functions" (p.59)

Connecting wireless speakers

For real surround playback with the TRUE X SURROUND function, connect dedicated wireless speakers (sold separately) to the sound bar.

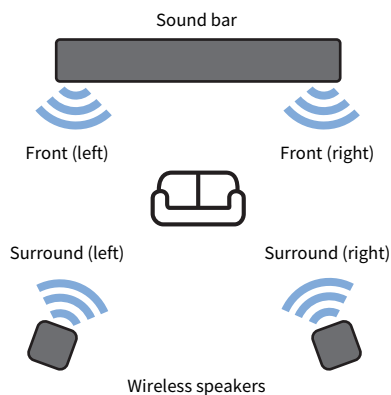

For the connection procedure of wireless speakers, see the following TRUE X SURROUND Connection and Operation Guide.

<https://manual.yamaha.com/av/truexsur/>

NOTE

For details on operating the wireless speakers, see also the User Guide.

PLAYBACK

Basic control during playback

This section describes the basic control operations available during playback.

■ Selecting an input source

Press one of the following input source buttons on the remote control.

- TV button: Audio from a TV
- HDMI button: Audio from a device connected to the HDMI IN input jack
- BLUETOOTH button: Audio from a Bluetooth device
- NET button: Audio from streaming services



The indicator on the front of the sound bar shows the selected input source as follows:

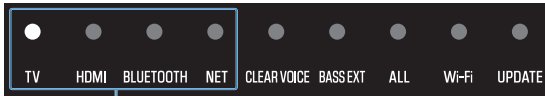

One of the indicators glows

■ Adjusting volume

Press VOLUME (+/-) on the remote control to adjust the volume.



The number of glowing indicators changes to show the volume level.

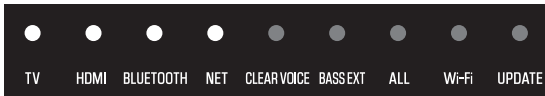



Volume is turned up (+)

Volume is turned down (-)

PLAYBACK > Basic control during playback

If audio is being output from both the TV speakers and the sound bar, mute the TV.

To temporarily mute the sound bar, press  (Mute) on the remote control. To unmute, press  (Mute) again or press VOLUME (+/-).



While muted, the indicators show the following.



Flash

Related links

- “Surround playback” (p.48)
- “Stereo playback” (p.49)
- “Adjusting the volume of the subwoofer” (p.50)
- “Playing back human voices clearly (CLEAR VOICE)” (p.51)
- “Enjoying rich bass sound (BASS EXT)” (p.52)
- “Listening to audio from a Bluetooth® device” (p.53)
- “Playing music using Sound Bar Controller” (p.55)
- “Listening to audio with AirPlay 2” (p.56)

Adjusting the sound to your preference

Sound functions of this product

This product is equipped with sound modes for surround playback and for stereo playback. There are also various sound settings for adjusting the sound to suit your preferences even better.

■ Sound modes

A sound mode can be selected from among three sound modes for surround playback and one sound mode for stereo playback.

STEREO

This sound mode provides stereo playback (2-channel stereo). This sound mode is best suited for music playback.

STANDARD

This sound mode provides surround playback that is best suited for TV programs such as sports broadcasts. It emphasizes the acoustic image of human voices and makes the voices easier to hear, while reproducing a wide sound field.

MOVIE

This sound mode provides surround playback that is best suited for movies. It reproduces a three-dimensional sound field and creates a sound space that seems to envelop your body. The sound characteristics settings can also be changed.

GAME

This sound mode provides surround playback that is best suited for video games. It accurately reproduces and emphasizes the localization of individual sound effects for a highly immersive gaming experience.

NOTE

- Audio input from BLUETOOTH or NET (such as streaming services) is played in stereo.
- For details on audio output when the TRUE X SURROUND function is used, see the following TRUE X SURROUND Connection and Operation Guide.
<https://manual.yamaha.com/av/truexsur/>
- Depending on the audio signal being played, it may take several seconds before sound is heard when switching sound modes.

■ Sound settings

The sound settings allow you to adjust the sound to better suit your preferences.

Clear Voice

The human voices within the audio can be heard more easily without turning up volume when the Clear Voice function is enabled. The function is recommended for enjoying movies or dramas at a low volume, and for movies or dramas that use a lot of background music and sound effects.

Bass Extension

The acoustic image of bass sound is enhanced when the Bass Extension function is enabled. It reproduces rich bass sound with strong presence by clarifying the acoustic image of bass sound without disturbing the balance of the overall sound.

NOTE

Depending on the audio signal being played, it may take several seconds before sound is heard when switching sound settings.

Related links

- “Surround playback” (p.48)
- “Stereo playback” (p.49)
- “Playing back human voices clearly (CLEAR VOICE)” (p.51)
- “Enjoying rich bass sound (BASS EXT)” (p.52)

Surround playback

Press STANDARD, MOVIE, or GAME on the remote control to switch to surround playback. Surround sound can be heard not only from horizontal directions, but also from varying heights. Select your preferred sound mode according to the content viewed or listened to.



NOTE

- The sound bar uses the following technologies to achieve a full surround sound experience.
 - Dolby Atmos: An object-based surround technology. Going beyond traditional channel-based approaches, it controls content audio as an assembly of many objects (a combination of audio information and information about sound location changes). This allows for more precise sound control and helps to reproduce sound that is more faithful to the intentions of content creators by taking advantage of the characteristics of the sound bar.
 - Height speakers: A dedicated speaker unit built in the top of the sound bar to output sound from varying heights.
- Audio from BLUETOOTH or NET (such as streaming services) is played in stereo regardless of the sound mode setting.

Related links

“Sound functions of this product” (p.46)

■ Switching the sound characteristics setting of MOVIE

The sound characteristics can be specified when the sound mode is set to MOVIE.

Press and hold MOVIE on the remote control for at least five seconds to switch between Setting 1 and Setting 2.

Setting 1: Ideal sound characteristics designed by Yamaha

Setting 2: Sound characteristics for the Dolby Atmos decoder

Default setting: Setting 1

When the setting is switched, the indicators on the front of the sound bar show the selected setting as follows:

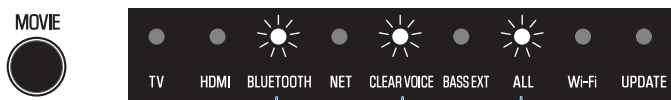

Flash once: Setting 1
Flash three times: Setting 2

NOTE

When the Clear Voice function is enabled, audio is always played with the sound characteristics of Setting 1.

Stereo playback

Press STEREO on the remote control to switch to stereo playback (2-channel stereo).



NOTE

To cancel stereo playback, press one of the following buttons: STANDARD, MOVIE, or GAME.

Related links

[“Sound functions of this product” \(p.46\)](#)

Adjusting the volume of the subwoofer

Adjust the volume of the subwoofer only.

Press SUBWOOFER (+/-) on the remote control to adjust the volume.

SUBWOOFER



The indicator on the front of the sound bar shows the volume level as follows:



Volume is turned down (-)

Volume is turned up (+)

Playing back human voices clearly (CLEAR VOICE)

The human voices within the audio can be heard more easily without turning up volume when the Clear Voice function is enabled. The function is recommended for enjoying movies or dramas at a low volume, and for movies or dramas that use a lot of background music and sound effects.

Press CLEAR VOICE on the remote control to enable or disable the function.

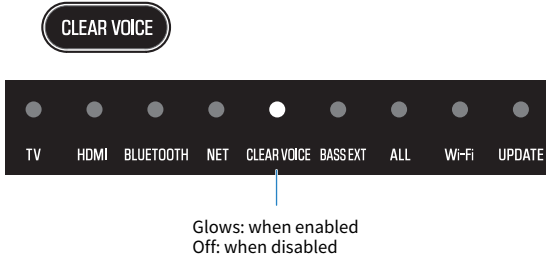

NOTE

Clear Voice is a function that focuses on and emphasizes the acoustic image of human voices within the audio. Only the human voices are emphasized without changing the overall volume and frequency characteristics, and it gives a clear sense of localization to the human voices.

Enjoying rich bass sound (BASS EXT)

The acoustic image of bass sound is enhanced when the Bass Extension function is enabled. The subwoofer volume remains the same, but the overall acoustic image of bass sound is adjusted to be more clear. Therefore, the presence of the acoustic image of the bass sound can be emphasized without disturbing the balance of the overall sound. This function is recommended when you want to increase the bass while suppressing the volume of the subwoofer, or when you want to emphasize the sounds of low-pitched instruments.

Press BASS EXT on the remote control to enable or disable the function.

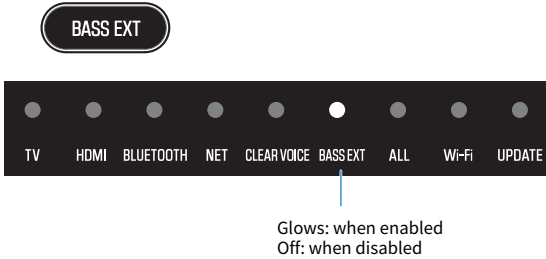

Listening to audio from a Bluetooth® device

Audio content from a Bluetooth device can be played through the sound bar.

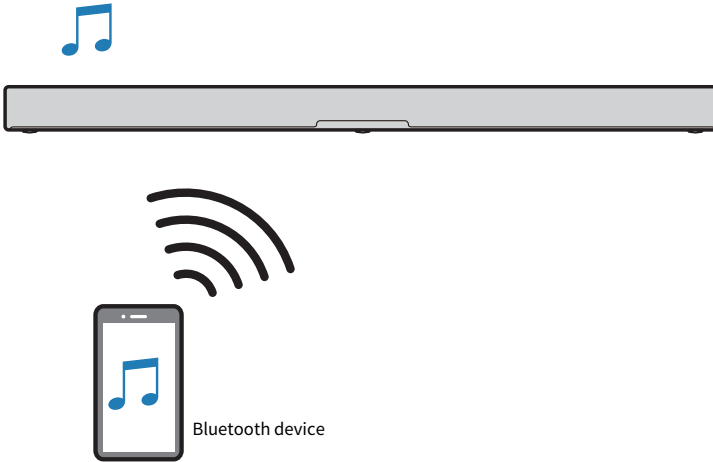

- 1 Press BLUETOOTH on the remote control to switch the input source of the sound bar to Bluetooth.**



The sound bar enters the connection wait status, and the BLUETOOTH indicator flashes.

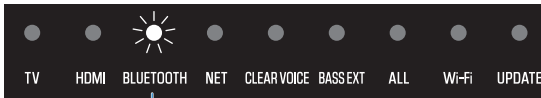

Flashes

- 2 On the Bluetooth device, enable the Bluetooth function.**

3 Select the sound bar on the Bluetooth device.

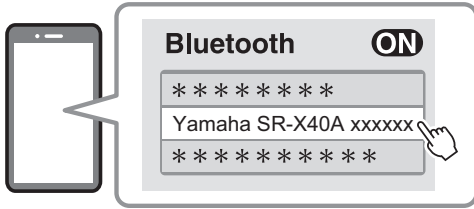

When the connection is established, the BLUETOOTH indicator on the sound bar stops flashing and starts glowing blue.

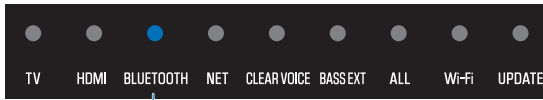

Glowing blue

4 Start playback on the Bluetooth device.

The sound bar will begin playing audio from the Bluetooth device.

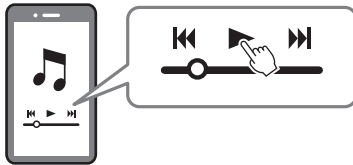

NOTE

- Enabling the network standby function allows the sound bar to be turned on automatically when a Bluetooth device connects to it.
- If other Bluetooth devices have been connected before, the sound bar will connect to the last connected device when the input source is switched to Bluetooth.
- The Bluetooth connection is terminated if one of the following operations is performed.
 - The Bluetooth function of the Bluetooth device is turned off.
 - BLUETOOTH on the sound bar's remote control is held down for at least five seconds.
 - An input source other than Bluetooth is selected on the sound bar.
 - Turn off the sound bar.
- Adjust the volume level of the Bluetooth device if necessary.
- Audio from a Bluetooth device is played in stereo regardless of the sound mode setting.

Related links

"Enabling/disabling the network standby function" (p.68)

Playing music using Sound Bar Controller

Streaming services

Content distributed by various streaming services on the Internet can be heard on the sound bar. Use the dedicated app for each streaming service or interact with Alexa to select streaming services and content.

See the product information page on the Yamaha website regarding which streaming services are currently supported by the product.

Additional information about each streaming service is also provided on the following website:

<https://manual.yamaha.com/av/sb/ss/sbc/>

NOTE

- A paid subscription may be required to listen to streaming services via the sound bar. For details about each streaming service, visit the website of the service provider.
- Services may change or be discontinued without notice. Please note that Yamaha Corporation does not accept any responsibility and will not be liable for any streaming service.
- Audio from streaming services is played in stereo regardless of the sound mode setting.

Listening to audio with AirPlay 2

Audio content can be played with AirPlay 2 on the sound bar. Tap (or click) the AirPlay icon on your iPhone or iTunes/Apple Music app and select the sound bar as the output destination.



CAUTION

- If the volume is adjusted on an AirPlay device, the volume may become unexpectedly loud, causing hearing impairment or damage to the device. If the volume becomes too loud during playback, stop playback immediately.

NOTE

- Enabling the network standby function allows the sound bar to be turned on automatically when playback is started on an AirPlay device.
- The network name of the sound bar displayed on the AirPlay device can be changed with the Sound Bar Controller app.
- Audio from an AirPlay device is played in stereo regardless of the sound mode setting.
- During playback, the volume of the sound bar can be adjusted from the AirPlay device.
- The sound bar supports AirPlay 2.
- For details about AirPlay, visit the Apple website.

Related links

“Enabling/disabling the network standby function” (p.68)

ADDITIONAL FEATURES

Changing the brightness of the indicators

Change the brightness of the indicators of the sound bar to one of three levels: “Bright”, “Dim”, or “Off”. The brightness is “Dim” by default.

- 1 Turn on the sound bar.**
- 2 Press  (Brightness) on the remote control.**



Press the button to change the brightness in the order of “Dim”, “Off” and “Bright”.

NOTE

- Indicators glow brightly just after operation and then change to the specified brightness after a few seconds.
- The Alexa indicator keeps glowing even when “Off” is selected. The Microphones Off indicator always glows at the same brightness level.

Using a TV's remote control to control the sound bar (HDMI Control)

When the sound bar is connected to a TV via an HDMI cable, the sound bar can be controlled using the TV's remote control. This is called the HDMI Control function.

TV's remote control (example)

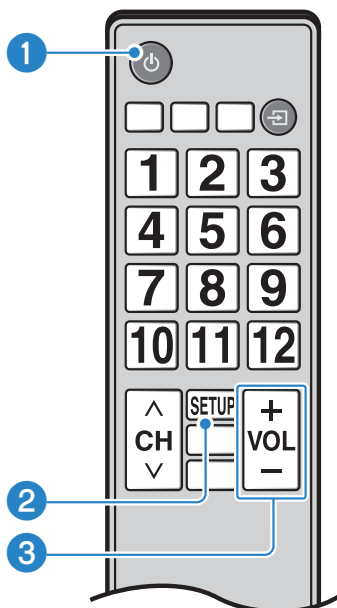

1 Turn the power on and off

Both the TV and the sound bar turn on/off at the same time.

2 Switch the audio output device

The audio output device can be switched to the TV or the sound bar. Control operations vary depending on the TV's type.

3 Adjust volume

The sound bar's volume can be adjusted when the TV's audio output is set to the sound bar.

Related links

["Enabling/disabling the HDMI Control function" \(p.64\)](#)

Showing the type of audio signal and settings for functions

The type of audio signal being played and settings for the sound bar's functions can be checked.

1 Press INFO on the remote control.



The indicators on the sound bar will show the following information on the type of audio signal and the settings for functions for three seconds immediately after INFO is pressed.

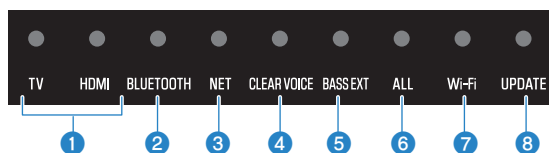

1 Type of audio signal

TV glows white, HDMI off: Dolby Audio (Dolby Digital/Dolby Digital Plus/Dolby TrueHD)
 TV glows red, HDMI off: Dolby Atmos
 TV glows white, HDMI glows white: AAC
 TV off, HDMI glows white: Other types of audio signals

2 Dynamic range compression level

Glow blue: Auto
 Glows white: Compression
 Off: No compression

3 Whether the Bluetooth function is enabled or disabled

Glow white: enabled
 Off: disabled

4 Whether the HDMI Control function is enabled or disabled

Glow white: enabled
 Off: disabled

5 Whether the Wi-Fi function is enabled or disabled

Glow white: enabled
 Off: disabled

6 Connection of a subwoofer

Glow white: connected
 Off: not connected

7 Connection of a surround speaker (left)

Glows white: connected
Off: not connected

8 Connection of a surround speaker (right)

Glows white: connected
Off: not connected

NOTE

If only one wireless speaker is registered, the Wi-Fi indicator glows white and the UPDATE indicator glows green when it is connected. When the wireless speaker is not connected, both the Wi-Fi and UPDATE indicators are off.

Controlling the sound bar with the smartphone app (Sound Bar Controller)

By installing the free dedicated app “Sound Bar Controller” on a smartphone, the sound bar can also be controlled from that smartphone.

[Search tag]#Q02 Network

Search for “Sound Bar Controller” on the App Store or Google Play and install it on the smartphone.



After installing the app on your smartphone, confirm that your smartphone is connected to the wireless network, and then open the app.

The app allows you to control the sound bar while checking its current settings via the following simple screen.

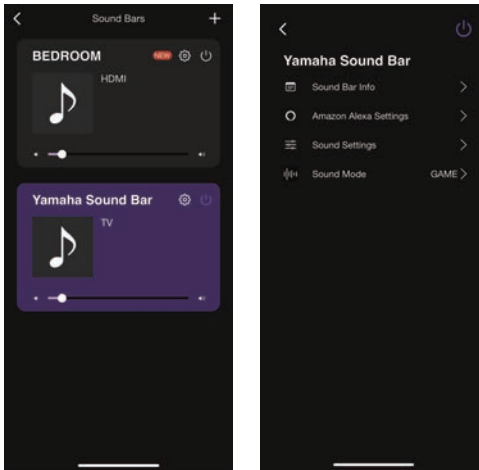

For details on the app, see the description of the app on the App Store or Google Play.

NOTE

- Confirm that your smartphone is connected to your home router before operation.
- This sound bar supports Sound Bar Controller only. This sound bar cannot be controlled using other apps (such as Sound Bar Remote).
- Amazon Alexa and streaming services are only provided in certain areas. Consequently, the contents of the menu displayed on the app screen or available functions may vary depending on the country or region where the product is used.

Controlling the sound bar by voice commands (Amazon Alexa)

Amazon Alexa is a cloud-based voice AI (Artificial Intelligence) provided by Amazon. Simply speak to the sound bar to wake Alexa and use voice commands to control the sound bar, play music, and more.

[Search tag]#Q03 Amazon Alexa

An Amazon account is required to use Alexa. The sound bar also needs to be connected to the Internet. Use the Sound Bar Controller app to enter your Amazon account information and log in to the service.

The functions of the sound bar that can be controlled with voice commands are as follows:

- Turning the power on and off
- Switching input sources
- Adjusting (or muting) the volume
- Switching between sound modes (STEREO / STANDARD / MOVIE / GAME)
- Selecting and playing streaming services
See the following website regarding streaming services that are supported by the sound bar.
<https://manual.yamaha.com/av/sb/ss/sbc/>

NOTE

- See the product information page on the Yamaha website for the latest information.
- A paid subscription may be required to listen to Amazon Music or Amazon Kindle on the product. For more information, visit the Amazon website.
- For information on other streaming services, visit the websites of those service providers.
- The language used by Alexa can be set when performing the initial setup for Alexa. It can also be changed in the Sound Bar Controller settings.
 - ⚙ (Settings) > Amazon Alexa Settings > Amazon Alexa Language
- Audio from streaming services is played in stereo regardless of the sound mode setting.
- Even if you tell Alexa to switch the input source to NET it will not be switched. Tell Alexa the name of the specific streaming service you want to play.

For example, say things like this to Alexa:

● **Adjust the volume**

“Alexa, turn up the volume.”

“Alexa, turn down the volume.”

● **Switch input sources**

“Alexa, switch the input source to HDMI.”

● **Listen to a streaming service (in the case of Amazon Music)**

“Alexa, play some jazz music.”

● **Control playback**

“Alexa, play next song.”

“Alexa, stop the music.”



“Alexa, what is this song?”

● **Check the weather**

“Alexa, what’s the weather today?”





Since Alexa responds differently depending on what it has learned, it may not function as intended even if you give it commands as in the examples above. If so, try another expression.

NOTE

- Alexa is a service provided by Amazon. This service may be changed, stopped, or terminated without notice. Please note that Yamaha Corporation does not accept any responsibility for any liabilities arising from continued provision or use of this service.
- Alexa is only provided in certain areas. Alexa may not be available in some countries or regions.
- Some functions require third party service agreements.
- If you want to prevent Alexa from accidentally responding, or to protect your privacy, press  (Microphones on/off) on the sound bar to disable the microphones.
- Instead of calling out “Alexa,” you can also press  (Action) on the remote control or  (Action) on the sound bar to make Alexa start listening for a command.
- The dedicated smartphone app “Amazon Alexa” provided by Amazon allows more detailed configuration and additional functions. For details, see the Amazon Alexa app’s help.

■ Alexa indicator displays

The Alexa indicator on the sound bar glows as follows, depending on the status of Alexa:

| Alexa Indicator (example) | Status of Alexa |
|---|---|
|  | Idle |
| Off | |
|  | Responding |
| Flashes blue and pale blue | |
|  | Notifications such as timers, alarms, and reminders |
| Flashes blue and pale blue rapidly | |
|  | A notification is received |
| Flashes yellow | |

Related links

“Connecting to a network” (p.38)

CONFIGURATION

Enabling/disabling the HDMI Control function

Enabling the HDMI Control function allows the sound bar to be controlled using the TV's remote control.

Default setting: Enabled

1 Turn off the sound bar.

2 Press and hold HDMI on the remote control for at least five seconds.



The HDMI Control function switches from enabled to disabled, or from disabled to enabled.

The indicators show the setting status as follows, and the sound bar is turned on.

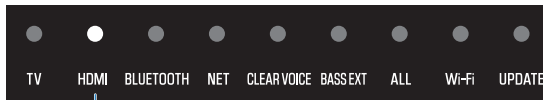

Glows: when enabled
Off: when disabled

NOTE

- To activate the Audio Return Channel (ARC), enable the HDMI Control function.
- Press INFO to see whether the HDMI Control function is enabled or disabled.
- When you want to reduce standby power consumption, disable the HDMI Control function. In this case, use the included remote control to control the sound bar.

Related links

- “Connecting to a TV using an HDMI cable (commercially available)” (p.27)
- “Connecting an AV device to the sound bar” (p.31)
- “Connecting an AV device to the TV's HDMI input jack” (p.33)
- “The sound bar cannot be controlled using the TV's remote control” (p.84)
- “Showing the type of audio signal and settings for functions” (p.59)
- “How to minimize standby power consumption” (p.103)

Switching the HDMI audio output destination

Switch the device that outputs audio that is input via the HDMI IN jack on the sound bar when the HDMI Control function is disabled.

The default setting is for the sound bar to output the audio.

| | |
|-----------|---|
| Sound bar | The sound bar will output audio that is input via the HDMI IN jack. |
| TV | The TV will output audio that is input via the HDMI IN jack. |

1 Turn off the sound bar.

2 Press and hold TV on the remote control for at least five seconds.

The HDMI audio output destination is changed.



The indicators show the setting status as follows, and the sound bar is turned on.

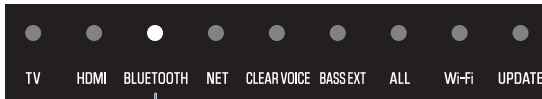

Glows: output from the sound bar
Off: output from the TV

NOTE

- When the TV outputs the audio that is input via the HDMI IN jack, the volume cannot be adjusted on the sound bar. Adjust the volume on the TV.
- To set the audio output device with the HDMI Control function enabled, select the device that outputs audio in the TV's settings.
- HDMI video signals input to the HDMI IN jack are always output to the HDMI OUT/TV (eARC) jack on the sound bar.

Related links

- "Enabling/disabling the HDMI Control function" (p.64)
- "Connecting an AV device to the sound bar" (p.31)

Enabling/disabling the Auto Power Standby function

When the Auto Power Standby function is enabled, the sound bar turns off in any of the following situations.

- No control operations for eight hours
- No signal input and no control operations for 20 minutes

If you want to avoid forgetting to turn off the sound bar, enable the Auto Power Standby function.

Default setting: Enabled

1 Turn off the sound bar.

2 While holding down on the sound bar, press the power button for at least five seconds.



The Auto Power Standby function switches from enabled to disabled, or from disabled to enabled.

The indicators show the setting status as follows, and the sound bar is turned on.

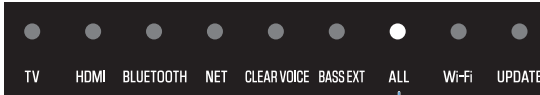

Glows: when disabled
Off: when enabled

NOTE

Depending on the connected device, signals may be output even when that device is in a playback-stopped state or standby state. For that reason, this product may not automatically turn off.

Enabling/disabling the Child Lock function

Enabling the Child Lock function locks the controls of the sound bar to prevent accidental operation. Even if the Child Lock function is enabled,  (Microphones on/off) can be operated.

Default setting: Disabled (the controls are unlocked)

- 1 Turn off the sound bar.**
- 2 Press and hold INFO on the remote control for at least five seconds.**



The Child Lock function switches from enabled to disabled, or from disabled to enabled.

The indicator shows the setting applied as follows, and the sound bar is turned on.



Glow: when the Child Lock function is enabled (the controls are locked)

Off: when the Child Lock function is disabled (the controls are unlocked)

NOTE

 (Microphones on/off) can be operated even when the Child Lock function is enabled (the controls are locked).

Enabling/disabling the network standby function

When the network standby function is enabled, the sound bar is turned on and off by operating a smartphone or Bluetooth device as follows:

Default setting: Enabled

- When the sound bar is off, the following operations will turn the sound bar on:
 - Playing with AirPlay
 - Playing audio content from a smartphone
 - Interacting with Alexa (with the microphones enabled)
- When a Bluetooth device connects to the sound bar while the sound bar is off, the sound bar is turned on, and the input source switches to Bluetooth.
- The sound bar can also be turned on and off using the Sound Bar Controller app installed on your smartphone.

1 Turn off the sound bar.

2 Press and hold GAME on the remote control for at least five seconds.



The network standby function switches from enabled to disabled, or from disabled to enabled.

The indicator shows the setting status as follows, and the sound bar is turned on.

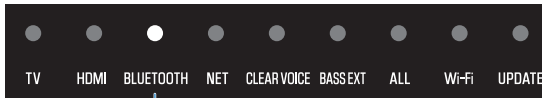

Glow: when enabled
Off: when disabled

NOTE

A very small amount of current flows through the sound bar even when it is in standby (power off state). When the network standby function is enabled, standby power consumption increases compared to the power off state.

Related links

“How to minimize standby power consumption” (p.103)

Enabling/disabling the Bluetooth function

The Bluetooth function can be disabled.

Default setting: Enabled

1 Turn off the sound bar.

2 Press and hold **BLUETOOTH** on the remote control for at least five seconds.

BLUETOOTH



The Bluetooth function switches from enabled to disabled, or from disabled to enabled.

The indicators show the setting status as follows, and the sound bar is turned on.

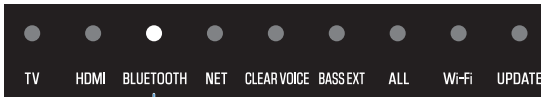

Glows: when enabled
Off: when disabled

NOTE

Press INFO to see whether the Bluetooth function is enabled or disabled.

Related links

“Showing the type of audio signal and settings for functions” (p.59)

Enabling/disabling the wireless (Wi-Fi) function

The wireless (Wi-Fi) function can be disabled.
Default setting: Enabled

- 1 Turn off the sound bar.**
- 2 Press and hold NET on the remote control for at least five seconds.**



The wireless (Wi-Fi) function switches from enabled to disabled, or from disabled to enabled.
The indicators show the setting status as follows, and the sound bar is turned on.

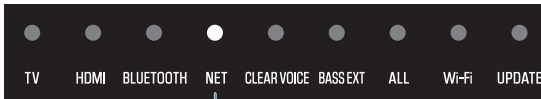

Glow: when enabled
Off: when disabled

NOTE

Press INFO button to see whether the wireless (Wi-Fi) function is enabled or disabled.

Related links

“Showing the type of audio signal and settings for functions” (p.59)

Setting the dynamic range compression level

Compressing the dynamic range of audio signals (the volume difference between the loudest and quietest sounds) makes it easier to listen at a low volume. This setting is applied only when Dolby Digital audio signals are being played.

Default setting: No compression

1 Turn off the sound bar.

2 Press the following remote control buttons according to the compression level you want to set:

| Compression level | Function | Buttons to press (On the remote control, press the buttons in order within three seconds) |
|-------------------|--|--|
| Auto | Apply an amount of dynamic range compression well suited for a typical room. | [STEREO] → [VOLUME +] → [⏻ (Power)] |
| Compression | Apply the maximum amount of dynamic range compression. | [STEREO] → [VOLUME -] → [⏻ (Power)] |
| No compression | Dynamic range compression is not applied. | [STEREO] → [🔇 (Mute)] → [⏻ (Power)] |

The dynamic range compression level setting is changed.

The indicators on the front of the sound bar show the setting status as follows, and the sound bar is turned on.

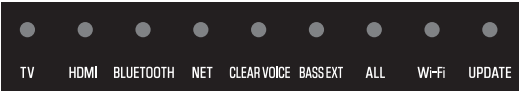
| Compression level | Sound bar's indicators |
|-------------------|---|
| Auto |  <p>Indicators not glowing</p> |
| Compression |  <p>Glow</p> |
| No compression |  <p>Glow</p> |

CONFIGURATION > Setting the dynamic range compression level

NOTE

Press INFO to see the setting of the dynamic range.

Related links

“Showing the type of audio signal and settings for functions” (p.59)

Updating the firmware of this product

New firmware may be provided to add features or fix bugs. The firmware can be updated with the Sound Bar Controller app installed on your smartphone.

[Search tag]#Q04 Update

NOTICE

- Do not operate the sound bar or unplug the power cord or network cable while updating the firmware.
- The firmware update may fail, depending on the connection status, such as if the Internet connection is not fast enough or when the sound bar is connected to a wireless network. In this case, try again at a later time.
- For more information about the firmware, visit the Yamaha website.

When a new firmware is released, the UPDATE indicator on the sound bar flashes green when the sound bar is turned on. Follow the Sound Bar Controller app screen instructions to update the firmware.

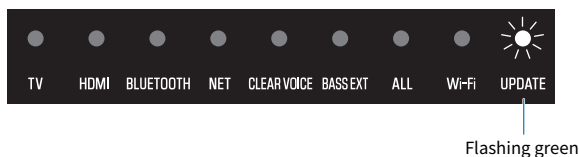

NOTE

The firmware can also be updated using a USB flash drive. For details, see the following Firmware Update Guide.
https://manual.yamaha.com/av/fwupdate/21/sr_ws/

Related links

“Controlling the sound bar with the smartphone app (Sound Bar Controller)” (p.61)

Setting the HDMI signal format

When some AV devices are connected to the sound bar, no sound can be heard, the colors of the video are not normal, or other abnormal conditions may occur.

Switching between the following modes may improve such conditions.

| | |
|--------|---|
| Mode 1 | Select this mode for normal use. |
| Mode 2 | Select this mode if an error occurs such as abnormal video. |

Default setting: Mode 1

- 1 Turn off the sound bar.**
- 2 Press and hold STEREO on the remote control for at least five seconds.**



The indicators show the setting status as follows, and the sound bar is turned on.

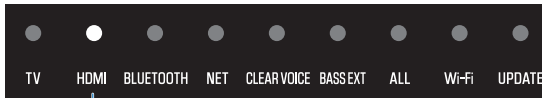

Glows: Mode 1
Off: Mode 2

Initializing the sound bar

Reset the settings of the sound bar to the factory presets.

- 1 Turn off the sound bar.**
- 2 While holding down + on the sound bar, press the power button until all indicators flash.**



The settings of the sound bar are initialized.

When initialization is complete, the indicators show the following and the sound bar is turned off.



Flashing: initialization complete



Flashing: In the process of turning on

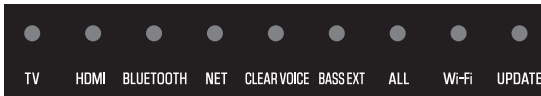

Off: Turned off

NOTE

When the SW-X100A subwoofer (sold separately) is connected, the connection information with the subwoofer will remain even if the settings of the sound bar are initialized.

TROUBLESHOOTING

Check the following first when any problem occurs

Make sure of the following when the product does not function properly.

- The power cords of all the devices are connected to AC wall outlets securely.
- The product, TV and AV devices are turned on.
- The connectors of each cable are securely inserted into the jacks on each device.

When a problem occurs: Power or overall functionality

The power turns off suddenly

● **The Auto Power Standby function turned off the sound bar.**

Enabling the Auto Power Standby function turns off the sound bar automatically in any of the following situations.

- No control operations for eight hours
- No signal input and no control operations for 20 minutes

Turn on the sound bar again. The Auto Power Standby function can be disabled.

- “Enabling/disabling the Auto Power Standby function” (p.66)

● **The protection circuitry has been activated. (The TV indicator on the sound bar flashes red.)**

After confirming that all connections are made properly, turn on the sound bar again. If the power still turns off frequently, unplug the power cord from the AC wall outlet and contact the nearest authorized Yamaha dealer or service center.

The power cannot be turned on

● **The protection circuitry has been activated three times consecutively. (The TV indicator on the sound bar flashes red.)**

To protect the product, the power cannot be turned on. Unplug the power cord from the AC wall outlet and contact the nearest authorized Yamaha dealer or service center.

● **The sound bar is in the process of turning on. (Some indicators on the front of the sound bar are flashing.)**

It takes approximately 1 minute for the sound bar to finish turning on after being connected to an AC wall outlet. Press  (Power) after the indicators turn off.

No operations can be performed from the sound bar's controls

● **The Child Lock function is enabled (the controls are locked).**

Disable the Child Lock function (so the controls are unlocked).

- “Enabling/disabling the Child Lock function” (p.67)

All indicators are off although the power is on (the power appears to be off)

● **Indicator brightness is set to “Off”.**

Change the brightness.

- “Changing the brightness of the indicators” (p.57)

The sound bar does not function correctly

- **The internal microcomputer is frozen due to an external electric shock (such as lightning or excessive static electricity) or to a drop in the power supply voltage.**

Press the power button on the sound bar for at least 15 seconds to force the sound bar to turn off. Wait for at least 10 seconds, then turn on the sound bar again.

The sound bar turns on by itself

● **Another Bluetooth device is being operated nearby.**

Terminate the Bluetooth connection with the sound bar.

- “Listening to audio from a Bluetooth® device” (p.53)

The sound bar cannot be controlled with the remote control

● **The sound bar is out of the operating range.**

Use the remote control within the operating range.

- “Part names of the remote control” (p.16)

● **The battery has run out.**

Replace the battery with a new one.

- “Replacing the remote control battery” (p.105)

● **The remote control sensor of the sound bar is exposed to direct sunlight or strong lighting.**

Adjust the lighting angle or reposition the sound bar.

The sound bar cannot be controlled using the TV's remote control

● The HDMI Control function is not properly configured.

Confirm that the settings are properly configured as follows:

- The HDMI Control function of the sound bar is enabled.
- The HDMI Control function is enabled on the TV.
- In the TV's HDMI settings, the audio output destination is set to an option other than the TV's built-in speakers.

If the sound bar still cannot be controlled with the TV's remote control, perform the following:

- Turn off the sound bar and the TV, and then turn them back on again.
- Unplug the power cord of the sound bar, as well as the power cords of external devices connected to the sound bar via an HDMI cable, from the AC wall outlet. Plug them in again after about 30 seconds.

Related links

["Enabling/disabling the HDMI Control function" \(p.64\)](#)

● The TV does not support the sound bar's control functions.

Even if your TV supports the HDMI Control function, some functions may not be available. For details, see the documentation supplied with your TV.

Alexa does not respond when called

● **Alexa is not properly configured.**

Configure it properly with the Sound Bar Controller app.

- “Controlling the sound bar by voice commands (Amazon Alexa)” (p.62)

● **The sound bar is not connected to a network.**

Connect the sound bar to a network.

- “Network functions” (p.38)
- “Connecting to a network using a network cable (wired connection)” (p.39)
- “Connecting to a network wirelessly (wireless connection)” (p.40)

● **Ambient noise is too loud.**

Alexa cannot hear the instructions when there is loud ambient noise. Eliminate the cause of the noise or speak more loudly and clearly.

● **The language setting for Alexa is different from the language being spoken to Alexa.**

Change the setting using the Sound Bar Controller app.

⚙️ (Settings) > Amazon Alexa Settings > Amazon Alexa Language

● **The microphones are off (the Microphones Off indicator glows red).**

Press  (Microphones on/off) on the sound bar to enable the microphones. When the microphones are enabled, the Microphones Off indicator turns off.

● **This product is being used in an area where Alexa is not provided.**

Alexa is only provided in certain areas. Alexa may not be available in some countries or regions where the product is used.

● **An Amazon account has not been set up on the sound bar.**

An Amazon account is required to call Alexa on the sound bar. Set up your Amazon account from the “Amazon Alexa” menu in the Sound Bar Controller app.

The UPDATE indicator is flashing green

● **A new firmware is released.**

Update the firmware with the Sound Bar Controller app.

- “Updating the firmware of this product” (p.73)

● **The product's firmware needs to be updated. (The UPDATE indicator is flashing rapidly.)**

A firmware update is necessary for some reason, such as when the firmware update failed. Update the firmware with the Sound Bar Controller app.

- “Updating the firmware of this product” (p.73)

When a problem occurs: Audio

No sound

● **The input source you are attempting to play back from is not selected.**

Select the correct input source.

- “Basic control during playback” (p.44)

● **The mute function is active.**

Cancel the mute function.

- “Basic control during playback” (p.44)

● **The volume is too low.**

Turn up the volume.

- “Basic control during playback” (p.44)

● **The power cord of the sound bar is not connected securely.**

Make sure that the power cord of the sound bar is properly connected to an AC wall outlet.

● **An input jack is connected to another input jack.**

Connect the input jack on the sound bar to the output jack on the AV device. When connecting the AV device to the TV, connect the output jack on the AV device to the input jack on the TV.

- “Connecting an AV device to the sound bar” (p.31)
- “Connecting an AV device to the TV’s HDMI input jack” (p.33)

● **A signal that the sound bar cannot play is being input.**

Change the digital audio output setting on the TV or AV device to a type of audio signal supported by the sound bar.

- “Supported digital audio signal formats” (p.113)

● **The HDMI Control function is disabled.**

When connecting a TV that supports the Audio Return Channel (ARC) to the sound bar using an HDMI cable only, enable the HDMI Control function.

To output audio from the sound bar when the HDMI Control function is disabled, connect the TV’s audio output jack to the sound bar’s TV jack (digital optical) via a digital optical audio cable.

- “Enabling/disabling the HDMI Control function” (p.64)
- “Connecting to a TV using an HDMI cable (commercially available)” (p.27)

● **The audio output destination of a TV using HDMI Control is the TV’s built-in speakers.**

In the TV’s HDMI settings, set the audio output destination to an option other than the TV’s built-in speakers.

No sound is coming from the subwoofer

● **The playback source does not contain subwoofer channel signals or low-frequency signals.**

Try to play content containing subwoofer channel signals, to see if any sound can be heard from the subwoofer.

● **The volume of the subwoofer is too low.**

Turn up the volume of the subwoofer.

- “Adjusting the volume of the subwoofer” (p.50)

No sound is coming from the subwoofer (when the SW-X100A dedicated subwoofer that is sold separately is connected)

● **The power cord of the subwoofer is not connected to an AC wall outlet.**

Connect the power cord of the subwoofer to an AC wall outlet.

● **The protection circuitry has been activated. (The STANDBY indicator on the rear of the subwoofer is flashing.)**

To protect the product, the power of the subwoofer cannot be turned on. Unplug the power cord from the AC wall outlet and contact the nearest authorized Yamaha dealer or service center.

● **Weak wireless signal. (The CONNECT indicator on the rear of the subwoofer is flashing slowly.)**

The condition of the wireless connection is bad, and the subwoofer cannot be connected to the sound bar. Try the following.

- Place the subwoofer closer to the sound bar.
- If metal furniture is placed between the sound bar and subwoofer, change the layout or relocate the subwoofer.
- If a device emitting electromagnetic waves (such as a microwave oven or a wireless LAN device) is located nearby, place the subwoofer and sound bar farther away from it.

● **The subwoofer is not connected to the sound bar. (The CONNECT indicator on the rear of the subwoofer is flashing slowly).**

Connect the subwoofer to the sound bar.

- “Connecting a subwoofer” (p.42)

The volume decreases when the sound bar is turned on

● **The Automatic Volume Adjustment function lowered the volume.**

To prevent unexpected excessive loudness, the sound bar is equipped with the Automatic Volume Adjustment function. If the sound bar was turned off with the volume set high, the volume is automatically adjusted to a safe listening level the next time the sound bar is turned on. Turn up the volume if necessary.

- “Basic control during playback” (p.44)

No surround effect

● **Stereo playback is selected.**

Select surround playback.

- “Surround playback” (p.48)

● **The volume is too low.**

Turn up the volume.

- “Basic control during playback” (p.44)

● **The TV or AV device is set to output 2-channel audio (such as PCM) only.**

Change the audio output setting on the TV or AV device to output Bitstream audio signals.

● **Sound is also heard from the TV’s built-in speakers.**

Turn the TV’s volume all the way down.

● **You are listening from a position that’s extremely close to the sound bar.**

You should listen at some distance from the sound bar.

● **Audio from a Bluetooth device or streaming services is being played.**

Audio input from BLUETOOTH or NET (such as streaming services) is played in stereo regardless of the sound mode setting.

Noise is heard

- **The sound bar is too close to another digital or high-frequency device.**

Move those devices away from the sound bar.

When a problem occurs: Bluetooth®

The sound bar cannot be connected to a Bluetooth® device

● **Bluetooth is not selected as the input source of the sound bar.**

Select Bluetooth as the input source.

- “Listening to audio from a Bluetooth® device” (p.53)

● **The sound bar is too far away from the Bluetooth device.**

Move the Bluetooth device closer to the sound bar.

● **A device emitting electromagnetic waves (such as a microwave oven or a wireless device) is located nearby.**

Do not use the sound bar near devices that emit electromagnetic waves.

● **The Bluetooth device you are using does not support the A2DP profile.**

Use a Bluetooth device that supports the A2DP profile.

● **The connection profile registered in the Bluetooth device is not functioning correctly.**

Delete the connection profile in the Bluetooth device, and then connect the Bluetooth device to the sound bar.

● **The passkey for devices such as a Bluetooth adapter is not “0000”.**

Use a Bluetooth device with a passkey of “0000”.

● **The sound bar is connected to another Bluetooth device.**

Terminate the current Bluetooth connection, and then connect to the new device.

● **The Bluetooth function of the sound bar is disabled.**

Enable the Bluetooth function.

- “Enabling/disabling the Bluetooth function” (p.69)

No sound can be heard or the sound cuts off intermittently from a Bluetooth® device

● **The volume on the Bluetooth device is too low.**

Raise the volume on the Bluetooth device.

● **Playback is not being performed on the Bluetooth device.**

Perform playback on the Bluetooth device.

● **The audio output destination on the Bluetooth device is not set to the sound bar.**

Select the sound bar as the audio output destination on the Bluetooth device.

● **The connection to the Bluetooth device was terminated.**

Connect to the Bluetooth device again.

● **The sound bar is too far away from the Bluetooth device.**

Move the Bluetooth device near the sound bar.

● **A device emitting electromagnetic waves (such as a microwave oven or a wireless device) is located nearby.**

Do not use the sound bar near devices that emit electromagnetic waves.

When a problem occurs: Network

Network functions cannot be used

- **The network information (IP address) is not being properly acquired.**
Enable the DHCP server function on the router.
- **You are trying to connect to an IPv6-type router.**
The sound bar does not support IPv6 networks. Connect the sound bar to an IPv4 network.

The sound bar cannot be connected to the Internet via a wireless LAN router (access point)

- **The wireless LAN router (access point) is off.**

Turn on the wireless LAN router (access point).

- **The sound bar is too far away from the wireless LAN router (access point).**

Install the sound bar and wireless LAN router (access point) closer to each other.

- **Obstacles are between the sound bar and wireless LAN router (access point).**

Install the sound bar and wireless LAN router (access point) in a place where no obstacles are between them.

- **The wireless LAN router (access point) is set to use a specific wireless channel.**

Change the settings of the wireless LAN router so that it automatically selects a channel. If you want to specify the channel to use, specify channel 1 or 11.

A wireless network cannot be not found

- **Electromagnetic waves being emitted from devices such as microwave ovens or from other wireless devices are obstructing the wireless communication.**

Turn off these devices or keep the sound bar and wireless LAN router (access point) away from these devices. Or, connect the sound bar to a 5 GHz-compatible wireless LAN router (access point).

- **Access to the network is limited by the way the firewall is configured on the wireless LAN router (access point).**

Check to see how the firewall is configured on the wireless LAN router (access point).

Audio cannot be played with AirPlay

- **An audio file not supported by the sound bar is being played.**

Play the file on an AirPlay-compatible device, to see if it can be played. If it cannot be played, the file format may not be supported, or the file may be corrupted.

The sound bar is not detected on an AirPlay-compatible device

- **The sound bar and an AirPlay-compatible device are each connected to different SSIDs.**

Connect the sound bar and AirPlay-compatible device to the same SSID (try connecting them to the primary SSID).

Streaming services cannot be played

- **The selected streaming service is currently stopped.**

Try playing the streaming service again later.

- **Access to the network is limited by the way the firewall is configured on the router or other network device.**

Check to see how the firewall is configured on the network device. Also, streaming services can only be played via the port specified by each service. The port number varies depending on the streaming service.

- **This product is being used in an area where streaming services are not provided.**

Streaming services are only provided in certain areas. Streaming services may not be available in some countries or regions where the product is used.

Unable to update the firmware via a network

- **The condition of the network connection is bad.**

Try updating the firmware again later, or perform the update using a USB flash drive. For details on how to update the firmware using a USB flash drive, see the following Firmware Update Guide.

https://manual.yamaha.com/av/fwupdate/21/sr_ws/

When a problem occurs: App

The app cannot detect the sound bar

● **An app not supported by the sound bar is being used.**

This sound bar supports Sound Bar Controller only. Sound Bar Remote, Home Theater Controller, and MusicCast Controller cannot be used.

● **The sound bar and smartphone are not connected to the same network.**

Check the network connection and the router's settings, and connect the sound bar and smartphone to the same network.

● **The smartphone is not connected wirelessly (via Wi-Fi) to the wireless LAN router.**

Connect the smartphone wirelessly (via Wi-Fi) to the wireless LAN router.

● **A router that supports multiple SSIDs is being used.**

The network splitting function of a wireless LAN router may prevent access to the sound bar. Connect the sound bar and smartphone to a network with the same SSID. Try connecting to the primary SSID first.

● **The wireless (Wi-Fi) function is disabled.**

Enable the wireless (Wi-Fi) function.

- “Enabling/disabling the wireless (Wi-Fi) function” (p.70)

How to minimize standby power consumption

Change the settings as follows:

- HDMI Control: Disabled
- Network Standby: Disabled

Related links

- “Enabling/disabling the HDMI Control function” (p.64)
- “Enabling/disabling the network standby function” (p.68)

How to replace the remote control battery

Precautions for remote control batteries

Before replacing the remote control battery with a new one, be sure to read the following precautions. Be sure to follow the precautions.



WARNING

- The remote control included with this product contains a coin/button cell battery. Do not ingest the coin/button battery. Keep new and used batteries away from children. If the battery compartment does not close securely, keep it away from children. If the coin/button cell battery is swallowed, it can cause severe chemical burns and dissolve tissues inside the body in less than 2 hours, and can lead to death. If you think batteries might have been swallowed or placed inside any part of the body, seek immediate medical attention.
- Do not dispose of a battery in fire. Do not expose a battery to high temperatures, such as direct sunlight or a fire. Do not attempt to charge the battery installed in the remote control. The battery could burst or leak, causing a fire or injury.
- Do not disassemble a battery. If the battery leaks, avoid contact with the leaked fluid. If the contents of the battery get on your hands or in your eyes, it can cause blindness or chemical burns. If the battery fluid should come in contact with your eyes, mouth, or skin, wash immediately with water and consult a doctor.



CAUTION

- Do not use a battery other than the specified one. Doing so may cause fire or burns, or result in fluid leakage that may cause skin inflammation.
- Always make sure the battery is inserted in conformity with the +/- polarity markings. Failure to do so might result in a fire, burns, or inflammation due to fluid leaks.
- When the battery runs out, or if the sound bar is not to be used for a long time, remove the battery from the remote control to prevent possible leakage of the battery fluid.
- Do not put in a pocket or bag, carry, or store batteries together with pieces of metal. The battery could short, burst, or leak, causing a fire or injury.
- When storing or discarding batteries, insulate the terminal area by applying tape, or some other protection. Mixing them with other batteries or metal objects can cause a fire, burns, or inflammation due to fluid.

Replacing the remote control battery

- Before replacing the battery with a new one, be sure to read the following precautions.
 - “Precautions for remote control batteries” (p.104)

When the battery runs out, the sound bar can no longer be controlled with the remote control. Replace the battery with a new one.

- 1 While holding down the part labeled PUSH on the back of the remote, slide the cover in the direction of the arrow to remove it.**

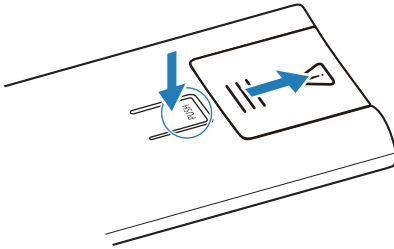

- 2 Insert an object such as a fine-tip ballpoint pen in the way shown by the arrow and remove the battery.**

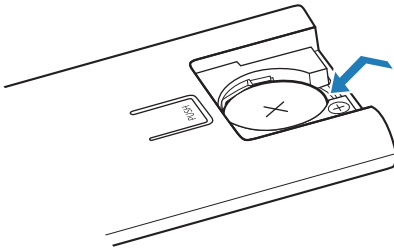

3 Insert a new battery and slide the cover back into its position in the direction of the arrow.

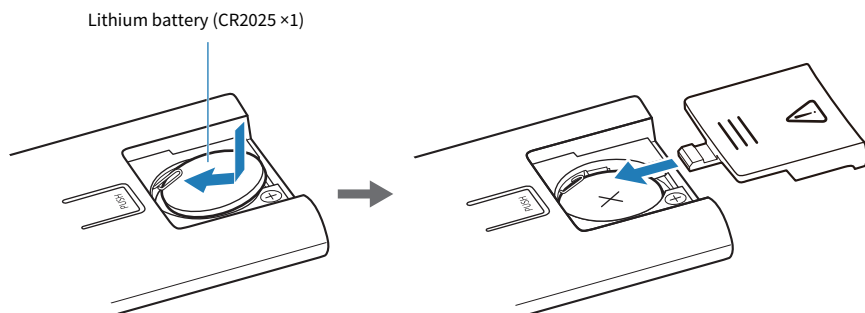

How to reset the sound bar

Reset the sound bar by performing the following operations.

■ Force the sound bar to turn off

Press the power button on the sound bar for at least 15 seconds.

■ To initialize the sound bar

Refer to the following explanation and reset the settings of the sound bar to the factory presets.

“Initializing the sound bar” (p.75)

SPECIFICATIONS

Specifications of this product

The specifications of this product are as follows.

Amplifier section

Maximum rated output power

- Front L/R 30 W × 2 channels
- Height L/R 30 W × 2 channels
- Subwoofer 30 W × 2

Speaker section

Front L/R

- Type Acoustic suspension type
(non-magnetic shielding)
- Driver 4.6 × 6.6 cm (1-3/4 × 2-5/8") cone × 2
- Frequency response 220 Hz to 22 kHz
- Impedance 6 Ω

Height L/R

- Type Acoustic suspension type (non-magnetic shielding)
- Driver 5.2 cm (2") cone × 2
- Frequency response 220 Hz to 22 kHz
- Impedance 6 Ω

Subwoofer

- Type Acoustic suspension type (non-magnetic shielding)
- Driver 7.5 cm (3") cone × 2
- Frequency response 55 Hz to 220 Hz
- Impedance 6 Ω × 2

Input jacks

Digital (optical) 1 (TV)

HDMI 1 (HDMI IN)

Output jacks

HDMI 1 (HDMI OUT/TV (eARC))

Other jacks

| | |
|-------------------------------|-----------------|
| USB | 1 (UPDATE ONLY) |
| Network (100BASE-TX/10BASE-T) | 1 (NETWORK) |

Bluetooth

| | |
|-----------------------|--|
| Function | Sink function (source device to this unit) |
| Bluetooth version | Ver 5.0 |
| Supported profiles | A2DP |
| Supported codecs | Sink function: SBC, MPEG-4 AAC |
| Bluetooth class | Bluetooth Class 2 |
| Range (line-of-sight) | Approx. 10 m (33 ft) |

[Models for U.K. and Europe]

- Radio frequency 2402 MHz to 2482 MHz
- Maximum output power (EIRP) 8.8 dBm (7.6 mW)

Wireless LAN

| | |
|-----------------------------|---------------------------------|
| • Wireless LAN standards | IEEE 802.11 a/b/g/n/ac* |
| | * 20 MHz channel bandwidth only |
| • Radio frequency band | 2.4 GHz/5 GHz |
| • Available security method | WPA, WPA2, WPA3 |

[Models for U.K. and Europe]

- Radio frequency: Maximum output power (EIRP)
 - 2.4 GHz band 2402 MHz to 2482 MHz (20 MHz): 19.2 dBm (83.2 mW)
 - 5 GHz band 5150 MHz to 5725 MHz (20 MHz): 20.9 dBm (123 mW)
5725 MHz to 5850 MHz (20 MHz): 14.0 dBm (25.1 mW)

Network audio function

| | |
|------------------|--|
| Supported codecs | WAV (PCM format only)/FLAC/AIFF/Ogg Vorbis: up to 192 kHz ALAC: up to 96 kHz MP3/WMA/MPEG-4 AAC/Ogg Opus: up to 48 kHz |
|------------------|--|

Communication between the sound bar and subwoofer

[Models for U.K. and Europe]

- Radio frequency 5775 MHz to 5875 MHz
- Maximum output power (EIRP) 13.8 dBm (24.0 mW)

General

Power supply

- Models for U.S.A., Canada, Brazil, Taiwan and Mexico AC 100 to 120 V, 50/60 Hz
 - Models for U.K., Europe, and other areas AC 100 to 240 V, 50/60 Hz
-

Power consumption 36 W (Rated)

Standby power consumption

- [Models for U.S.A., Canada, Brazil, Taiwan and Mexico]
 - HDMI Control/Network Standby: Off 0.5 W
 - HDMI Control/Network Standby: On 2.0 W
 - [Models for U.K., Europe, and other areas]
 - HDMI Control/Network Standby: Off 0.5 W
 - HDMI Control/Network Standby: On 2.0 W
-

Dimensions (W x H x D)

- Installing the Sound Bar in front of a TV, etc. 1015 × 63 × 112 mm
(40" × 2-1/2" × 4-3/8")
 - Mounting the Sound Bar on a wall, with spacers 1015 × 63 × 120 mm
(40" × 2-1/2" × 4-3/4")
-

Weight 3.9 kg (8.5 lbs)

NOTE

The contents of this User Guide apply to the latest specifications as of the publishing date. To obtain the latest User Guide, access the Yamaha website then download the User Guide.

Supported HDMI video/audio signal formats

The following HDMI video/audio signals are supported by this product.

Audio signals (audio input signals of the HDMI IN jack and HDMI OUT/TV (eARC) jack)

The following audio signals can be played on this product when they are input from the HDMI output jack of the AV device to the HDMI IN jack on the sound bar, and from the eARC-compatible HDMI input jack on the TV to the HDMI OUT/TV (eARC) jack on the sound bar:

| Audio formats | Details |
|--------------------------|--|
| 2-channel Linear PCM | 2 channels, 32 / 44.1 / 48 / 88.2 / 96 / 176.4 / 192 kHz, 16 / 20 / 24-bit |
| Multi-channel Linear PCM | 8 channels, 32 / 44.1 / 48 / 88.2 / 96 / 176.4 / 192 kHz, 16 / 20 / 24-bit |
| Bitstream | Dolby Digital / Dolby Digital EX / Dolby Digital Plus / Dolby TrueHD / Dolby Atmos |

Video signals

The following video signals are supported.

- Deep Color
- x.v.Color
- 3D video signals
- High Dynamic Range (HDR) video signals
 - HDR10
 - HLG
 - Dolby Vision

The following resolutions are supported.

- VGA
- 480i / 60 Hz
- 480p / 60 Hz
- 576i / 50 Hz
- 576p / 50 Hz
- 720p / 60 Hz, 50 Hz
- 1080i / 60 Hz, 50 Hz
- 1080p / 60 Hz, 50 Hz, 24 Hz
- 4K / 60 Hz, 50 Hz, 30 Hz, 25 Hz, 24 Hz

Copyright protection standards

HDCP 2.3 compliant

NOTE

- See also the instruction manual supplied with the AV device for details on how to connect it to the sound bar.
- When playing audio from a copy-protected DVD, video and/or audio signals may not be output depending on the DVD player being used.
- The sound bar does not support TVs or projectors equipped with HDMI or DVI jacks that are not HDCP compatible. See the instruction manual supplied with the HDMI or DVI device to check whether it is HDCP-compatible.
- To decode Bitstream audio signals, change the settings on the AV device so that the AV device directly outputs Bitstream signals. See the instruction manual supplied with the AV device for more information.
- The resolution at which video signals are transmitted varies depending on the specifications of the connected TV.
- The contents of this User Guide apply to the latest specifications as of the publishing date. The latest version of the User Guide is available to download from the Yamaha website.

Supported digital audio signal formats

The following digital audio signals are supported by this product.

Audio input signals of the HDMI OUT/TV (eARC) jack

The following digital audio signals can be played on this product when they are input from the ARC-compatible HDMI input jack on the TV to the HDMI OUT/TV (eARC) jack on the sound bar:

| Audio formats | Details |
|----------------------|--|
| 2-channel Linear PCM | 2 channels, 32 / 44.1 / 48 / 88.2 / 96 / 176.4 / 192 kHz, 16 / 20 / 24-bit |
| Bitstream | Dolby Digital / Dolby Digital EX / Dolby Digital Plus / Dolby Atmos |

Audio input signals of the TV jack

The following digital audio signals can be played on this product when they are input from the digital optical output jack on the TV to the TV jack on the sound bar:

| Audio formats | Details |
|----------------------|--|
| 2-channel Linear PCM | 2 channels, 32 / 44.1 / 48 / 88.2 / 96 kHz, 16 / 20 / 24-bit |
| Bitstream | Dolby Digital / Dolby Digital EX |

NOTE

The contents of this User Guide apply to the latest specifications as of the publishing date. The latest version of the User Guide is available to download from the Yamaha website.

List of indicator displays

The indicators of the sound bar display information primarily in the following ways:

NOTE

This guide shows indicator glowing status as follows:



Off



Glowing



Flashing

Power off state

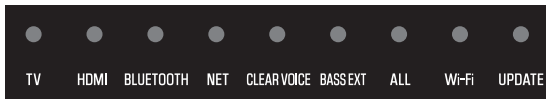

Normal playback state

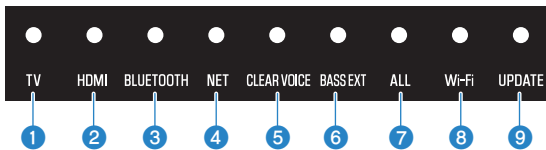

- 1 TV**
Glowing white: Playing audio from the TV
- 2 HDMI**
Glowing white: Playing audio from the HDMI IN jack
- 3 BLUETOOTH**
Glowing blue: Bluetooth device connection established
Flashing white: Bluetooth device connection wait status
- 4 NET**
Glowing white: Playing audio from a network
- 5 CLEAR VOICE**
Glowing white: Clear Voice function is enabled
Off: Clear Voice function is disabled
- 6 BASS EXT**
Glowing white: Bass Extension is enabled
Off: Bass Extension is disabled

SPECIFICATIONS > List of indicator displays

7 ALL

Glowing white: ALL mode is enabled
Off: ALL mode is disabled

8 Wi-Fi

Glowing white: Wi-Fi connected
Flashing white: establishing the Wi-Fi connection
Off: Wi-Fi disconnected

9 UPDATE

Flashing green: New firmware is available
Off: No new firmware

Muted state



Invalid operation

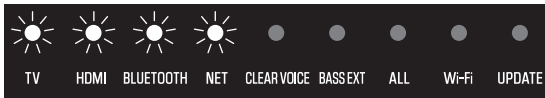

An error occurred

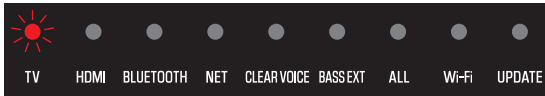

Flashes red

Showing the type of audio signal and settings for functions

The indicators on the sound bar will show the following information on the type of audio signal and the settings for functions for three seconds immediately after INFO on the remote control is pressed.

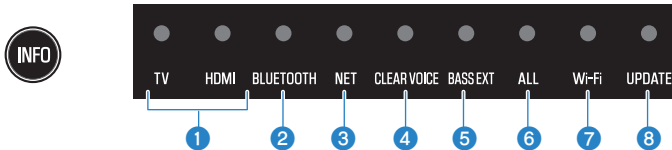

1 Type of audio signal

TV glows white, HDMI off: Dolby Audio (Dolby Digital/Dolby Digital Plus/Dolby TrueHD)
TV glows red, HDMI off: Dolby Atmos
TV glows white, HDMI glows white: AAC
TV off, HDMI glows white: Other types of audio signals

2 Dynamic range compression level

Glows blue: Auto
Glows white: Compression
Off: No compression

3 Whether the Bluetooth function is enabled or disabled

Glows white: enabled
Off: disabled

4 Whether the HDMI Control function is enabled or disabled

Glows white: enabled
Off: disabled

5 Whether the Wi-Fi function is enabled or disabled

Glows white: enabled
Off: disabled

6 Connection of a subwoofer

Glows white: connected
Off: not connected

7 Connection of a surround speaker (left)

Glows white: connected
Off: not connected

8 Connection of a surround speaker (right)

Glows white: connected
Off: not connected

If only one wireless speaker is registered, the Wi-Fi indicator glows white and the UPDATE indicator glows green when it is connected. When the wireless speaker is not connected, both the Wi-Fi and UPDATE indicators are off.

NOTE

- When the brightness of the indicators is set to “Off”, the indicators glow only during control operations.
- See the description of each setting for what the indicators will show when the setting is changed.

Related links

- “Basic control during playback” (p.44)
- “Adjusting the sound to your preference” (p.46)
- “Changing the brightness of the indicators” (p.57)
- “When a problem occurs: Power or overall functionality” (p.77)

APPENDIX

Trademarks

The following trademarks are used in this guide.

COMPATIBLE WITH



Dolby, Dolby Vision, Dolby Atmos, and the double-D symbol are trademarks of Dolby Laboratories Licensing Corporation. Manufactured under license from Dolby Laboratories.

Confidential unpublished works. Copyright © 2012–2022 Dolby Laboratories. All rights reserved.



HIGH-DEFINITION MULTIMEDIA INTERFACE

The terms HDMI, HDMI High-Definition Multimedia Interface, HDMI Trade Dress and the HDMI Logos are trademarks or registered trademarks of HDMI Licensing Administrator, Inc.



The Bluetooth® word mark and logos are registered trademarks owned by Bluetooth SIG, Inc. and any use of such marks by Yamaha Corporation is under license. Other trademarks and trade names are those of their respective owners.



Amazon, Alexa, Amazon Music, Kindle and all related logos are trademarks of Amazon.com, Inc. or its affiliates.



The Wi-Fi CERTIFIED™ Logo is a registered trademark of Wi-Fi Alliance®.

Wi-Fi and Wi-Fi CERTIFIED are registered trademarks or trademarks of Wi-Fi Alliance®.

x.v.Color™

“x.v.Color” is a trademark of Sony Corporation.



To control this AirPlay 2-enabled speaker, iOS 11.4 or later is required.

Use of the Works with Apple badge means that an accessory has been designed to work specifically with the technology identified in the badge and has been certified by the developer to meet Apple performance standards.

Apple, AirPlay, Apple TV, Apple Watch, iPad, iPad Air, iPad Pro, iPhone, Lightning, and iTunes are trademarks of Apple Inc., registered in the U.S. and other countries and regions.

App Store

App Store is a service mark of Apple Inc., registered in the U.S. and other countries.

Android Google Play

Android and Google Play are trademarks of Google LLC.

GPL/LGPL

This product utilizes GPL/LGPL open-source software in some sections. You have the right to obtain, duplicate, modify, and redistribute this open-source code only. For information on GPL/LGPL open source software, how to obtain it, and the GPL/LGPL license, refer to the Yamaha Corporation website

(https://manual.yamaha.com/av/cm/sla/21/sr_ws/).

List of support centers

If the trouble still cannot be solved, please contact us for product support as shown below.

For customers within Japan

- Please contact the store where you purchased this product, or the Product Support Center as listed in the “Quick Start Guide” included with this product.

For customers outside of Japan

- Please contact your nearest authorized Yamaha dealer or service center.
<https://manual.yamaha.com/av/support/>

Yamaha Global Site
<https://www.yamaha.com/>

Yamaha Downloads
<https://download.yamaha.com/>

© 2023 Yamaha Corporation

Published 07/2023 NV-A0

AV21-0003