

# KR series

## USER MANUAL

KR-10  
KR-12



Lynx Pro Audio S.L.



KR-10



KR-12

## Manufacturer



LYNX Pro Audio S.L.  
Calle 1 - Pol. Ind. Picassent  
E-46220 Picassent (Valencia)



**CE CERTIFICATION, EUROPEAN PRODUCT**

This user guide is property of Lynx Pro Audio S.L. Any reproduction of this manual, by any means is strictly prohibited.  
Copyright 2020. All rights reserved.

## INTRODUCTION

To facilitate the correct and reliable use of the KR cabinets we have designed this instruction manual, please read it before proceeding to install the cabinet.

Please observe the technical data carefully and do not ignore the instructions included within this manual.

The two full-range models belonging to the KR Series have been specifically designed for club applications including KTV, Karaoke venues where high volume is required whilst delivering excellent vocal clarity with low distortion. KR-Series are available in two-way passive 10" and 12" versions.

## CONTENTS

• SAFETY PRECAUTIONS	4
• SYSTEM OVERVIEW	
KR-10	5
KR-12	6
• CONNECTORS AND CONNECTIONS	7
• CABINET CONNECTIONS	9
• HARDWARE AND ACCESSORIES	10
• HOW TO USE ACCESSORIES FOR INSTALLATION	11
• RAINBOW 3D ACOUSTIC SIMULATION SOFTWARE	15
• CERTIFICATIONS AND GUARANTEE	16

Before starting to use this device, please read this instruction manual carefully.  
Keep these instructions in the place where the equipment will be used and with easy access to them.

• **Electrical appliance**



The exclamation mark within a triangle identifies the presence of electricity. Use the system carefully without wet hands or feet. Avoid installing the speaker in wet or excessively humid places. Do not place material that contains liquid on or near the unit. Avoid dripping or splashing water or any liquid over the unit. Regularly check the condition of the cables and make sure these are not being walked on or pinched. Connect the speaker to bipolar, earthed mains. The mains plug must be connected to the appropriate protection (fuse or breaker). Connection to any other type of mains could result in an electrical shock and violate local electrical codes.

CAUTION: DO NOT CONNECT OR DISCONNECT THE AC POWER CONNECTORS UNDER LOAD.

• **Heavy equipment**



Apply back protection when using the system. Avoid loading and unloading at heights.

• **Electrical shock risk**



The diagonal mark within a triangle identifies the presence of dangerous voltage.

Do not open or handle the interior of the box. These parts are not to be adjusted by the user. For maintenance and/or repair please go to an authorized service centre. In order to reduce the risk of electric shock, disconnect from AC before plug in or unplugging Audio signal cables. Reconnect to AC only if all signal connections are made and secured. Never manipulate the ground type plug provided.

The AC mains plugs should always remain accessible for operation.

Unplug the loudspeaker during storms or when it's being used for a long time.

• **Hearing damage risk**



These systems can reproduce large quantities of sound pressure which can damage hearing. Take precautions if you are going to be near them for extended amounts of time and do not get too close.

• **Hanging / Flying**



Do not hang the cabinets from the handles or from any other part other than the designated hanging point. When flying this system please observe the technical and "Rainbow" software data carefully. Never exceed the maximum safe working loads or ignore the instructions included within this manual. Use Only flying accessories provided by Lynx Pro Audio S.L. Rigging must be always carried out by professionals.

• **Delicate Material**



Please ensure no foreign object or water enters the speaker. Only clean the unit with dry cloths. Do not use solvents.

• **Overheating / Fire risk**



To reduce the risk of the speaker over heating, avoid direct contact with sunlight. Avoid placing the unit close to heat inducing objects such as radiators. Do not cover the equipment in use and do not block any ventilation openings. Do not put naked flame, such as lighted candles, close or on top of the unit.

• **Electromagnetic and interferente emissions**



Avoid placing objects which through electromagnetic waves can damage the unit, such as mobile phones, lap tops, magnetic strip cards etc.

This system complies with normatives

EN 55103-1 (1)

EN 55103-2 (2)

(1) This device may not cause harmful interferences.

(2) This device may receive interference including interferences that may cause undesired working.

• **IMPORTANT NOTE**



This Equipment must be used in accordance with these instructions and by trained professional personnel only. This equipment should not be used in places with extreme tropical climates. Don't expose this apparatus to extreme humidity and or temperature values.

## SYSTEM OVERVIEW

- KR-10:

Compact, two-way passive cabinet. Consists of a 10" (2" voice coil) LF transducer and a 1" HF driver mounted on a 90° x 60° rotatable horn.

- Technical Data:

Components:

- LF 10" speaker, 2.5" (50 mm) fiber glass former and aluminium winding voice coil, waterproof cone with treatment on both sides
- HF 1" exit throat (38 mm) voice coil, BMS annular diaphragm driver

Frequency range: 65 Hz – 22 KHz (-10dB)

Sensitivity: 96 dB

Max SPL / Peak: 122 dB/ 128 dB peak

Rated power: 300 W AES (600 W program, 1200 peak)

Dispersion: 90° x 60° rotatable

Nominal Impedance: 8 Ω

Connectors: 2 X NEUTRIK Speakon NL4MP Pin connections: +1 / -1 input +1 / -1 link

Finish: Polyurea coating high grade resistant paint

Material: 15 mm Premium MDF

Dimensions: 550 x 295 x 330 mm (H x W x D)

Weight: 16 Kg (35.2 lbs)

Fittings: 14 x M8, ergonomic handle on the back position, 4 x M6 U-bracket, 6 x M6 wall bracket, 35 mm top hat

Accessories: U bracket horizontal & vertical, M8 eyebolts, wall bracket

- KR-10 measurements

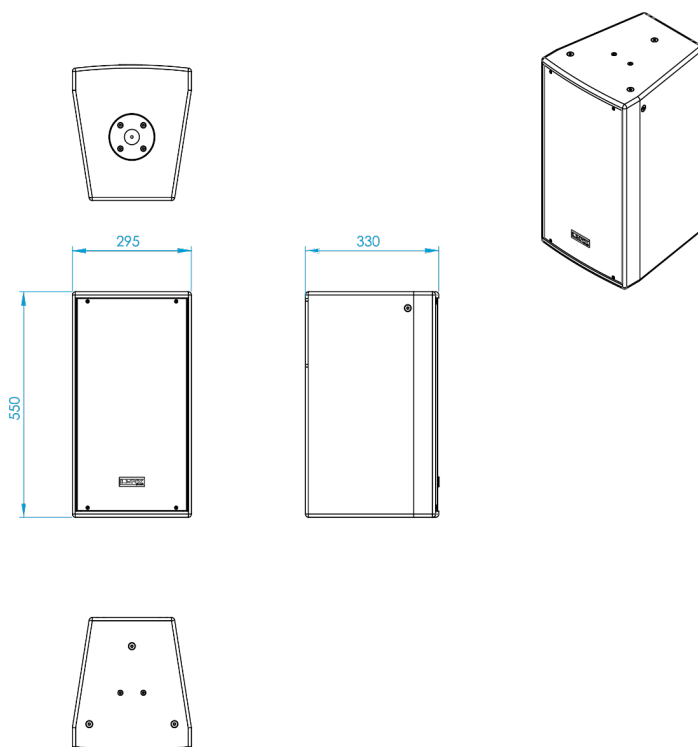

## SYSTEM OVERVIEW

- KR-12

Compact, two-way passive cabinet. Consists of a 12" (3" voice coil) LF transducer and a 1" HF driver mounted on a 90° x 60° rotatable horn.

- Technical Data:

Components:

- LF 12" speaker, 3" (75 mm) copper wire voice coil, waterproof cone with treatment on both sides
- HF 1" exit throat (38 mm) voice coil, BMS annular diaphragm driver

Frequency range: 58 Hz – 22 KHz (-10dB)

Sensitivity: 97 dB

Max SPL / Peak: 124 dB/ 130 dB peak

Rated power: 500 W AES (1000 W program, 2000 peak)

Dispersion: 90° x 60° rotatable

Nominal Impedance: 8 Ω

Connectors: 2 X NEUTRIK Speakon NL4MP Pin connections: +1 / -1 input +1 / -1 link

Finish: Polyurea coating high grade resistant paint

Material: 15 mm Premium MDF

Dimensions: 600 x 363 x 410 mm (H x W x D)

Weight: 24 Kg (52.9 lbs)

Fittings: 14 x M8, ergonomic handle on the back position, 4 x M6 U-bracket, 4 x M6 wall bracket, 35 mm top hat

Accessories: U bracket horizontal & vertical, M8 eyebolts, wall bracket

- KR-12 measurements

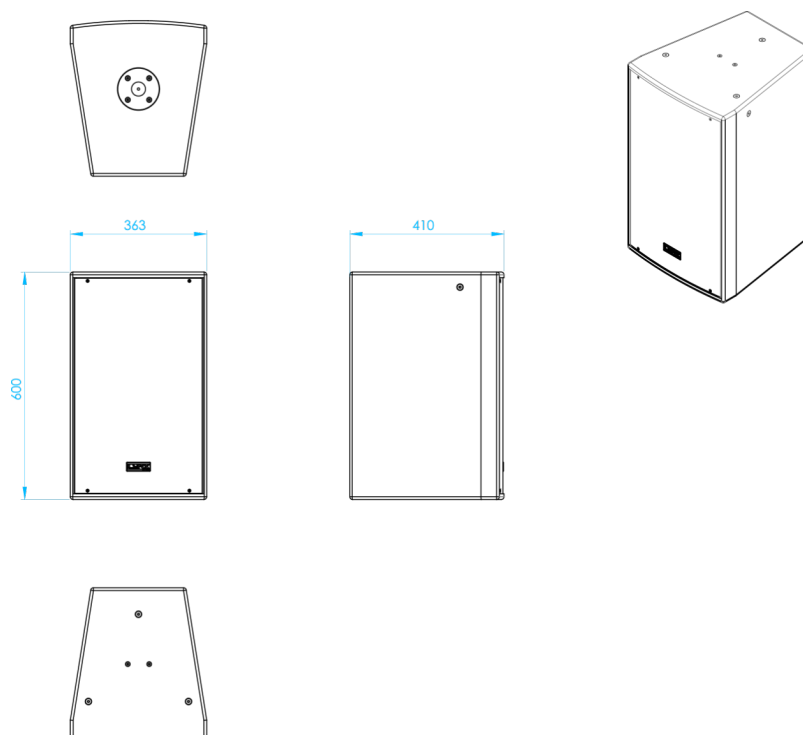

## CONNECTORS AND CONNECTIONS

### 2.1 Normative

The KR cabinets meet the following standards:

EN 55032:2012	Electromagnetic compatibility of multimedia equipment. Emmission requeriments.
EN 55103-2:2009 Immunity.	Electromagnetic compatibility. Product family standard for audio, video, audiovisual and entertainment lighting control apparatus for professional use. Part 2:
EN 60065:2014	Audio, video and similar electronic apparatus. Safety requirements.
EN 50581:2012	Technical documentation for the assessment of electrical and electronic products with respect to the restriction of hazardous substances

BS cabinets are in conformity with the following EC directives:

Low Voltage Directive	2014/35/UE
Electromagnetic Compatibility EMC	2014/30/UE
RoHS Directive	2011/65/UE
RAEE (WEEE)	2012/19/UE

### 2.2 Connectors

The KR cabinets have a connection panel at the rear of the cabinet. This consists of 2 internally bridged Neutrik NL4-MP connectors which apply no process to the signal.

Note: If pins +-2 are not used they will still be internally bridged.

The following table indicates which pins are used for all the models, with passive and bi-amplified modes.

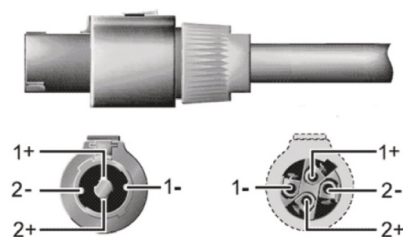

Cabinet	Connector	Speakon connections	per box	Impedance	Rated power	Program power
KR-10	NL4MP	± 1 input / link	2	8 ohms	300 W AES	600 W
KR-12	NL4MP	± 1 input / link	2	8 ohms	500 W AES	1000 W

## CONNECTORS AND CONNECTIONS

To connect the speakon follow the instructions in fig. 1

FIG1

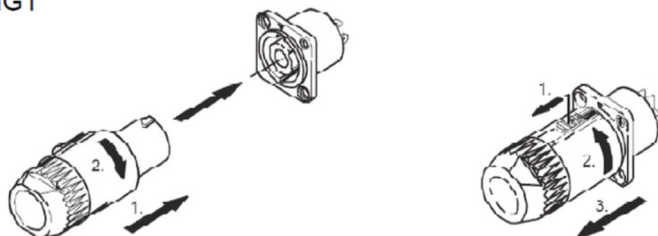

Insert the male speakon in its corresponding hole and turn right until it clicks. This fixes it safely and strongly and helps stop it being pulled out by mistake. At the other end of the cable connect in the same way to the amplifier channel.

### 2.3 Recommendations

Always ensure cables are in good condition. Know the recommended cable length and thickness according to the cabinet and quantity you are installing. An incorrect connection can affect the functioning of the system or even damage it. Cable thickness will vary according to cabinet impedance, quantity and distance. This is especially important when connecting Subwoofers.

As a guide, please see the following table which outlines the thickness depending on the power and length of cable.

Maximum recommended cable length for low impedance systems						
Wire section	AWG number	Cable resistance in 100 meters	Maximum recommended length (in pieces)			
			2 Ω	4 Ω	8 Ω	16 Ω
13.3 mm	6	0.25 ohm	24	57	122	253
6.63 mm	8	0.49 ohm	12	28	61	126
5.26 mm	10	0.62 ohm	10	23	48	100
3.31 mm	12	0.99 ohm	6	14	30	63
2.08 mm	14	1.57 ohm	4	9	19	40
1.31 mm	16	2.49 ohm	2	6	12	25
0.82 mm	18	3.98 ohm	2	4	8	16
0.52 mm	20	6.28 ohm	1	2	5	10
0.33 mm	22	9.89 ohm	1	1	3	6

Bear in mind Ohm ratings on the amplifiers used to power the cabinets. For example, 2 ohm amplifier configurations are not recommended due to the excessive power from the amp output.

Never connect more cabinets than recommended in parallel. With parallel connections, the total impedance can be calculated by dividing the impedance of 1 cabinet by the number connected.



## CABINET INSTALLATION

- **Mounting advice**

The KR cabinets are designed to be used in all kind of fixed installations.

Cabinets must be installed and suspended by professional installers.

Never place the safety of personnel at risk. Always check the accessories, slings etc are in good condition and the suspension point is secure and free of excess weight, vibration, etc. Be careful where the cabinets are suspended from.

All responsibility lies with the installation company.

- **Coverage change with the rotatable horn**

All the KR full range cabinets enable the horn to be rotated offering further coverage options. The rotatable horn feature enables the installer to also set the cabinet up horizontally whilst maintaining the horn features such as horizontal and vertical coverage. This is helpful in installs with low ceilings or where esthetically the cabinet looks better horizontally.

The following KR cabinets have rotatable horns:

KR-10 (90°x60°)

KR-12 (90°x60°)

To turn on the horn the user must first remove the cabinet grill, unscrew the horn, rotate it 90° and screw it back in. Be sure to maintain the connection and put the grill back on.



## HARDWARE AND ACCESSORIES

---

The KR cabinets are designed to be used in installations and the full range cabinets come with rigging points so that they can be easily installed. To fix the cabinets to a wall or to hold them from the ceiling is very easy using some simple accessories:



**AGR-8**

M8 eyebolt for the KR-10 and KR-12

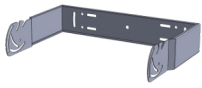

**UBR-KR10/KR12**

U bracket for the KR-10 and KR-12 cabinets

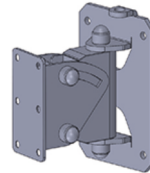

**WB-20/2**

Wall bracket for the KR-10 and KR-12 cabinets

## HOW TO USE ACCESSORIES FOR INSTALLATION

- **UBR (U bracket):**

UBR is the horizontal mounting system specially designed for Lynx Pro Audio cabinets. It is composed by the U type support made of steel and 4 special fixing screws (2 per side) in order to fix the cabinet to the U support.

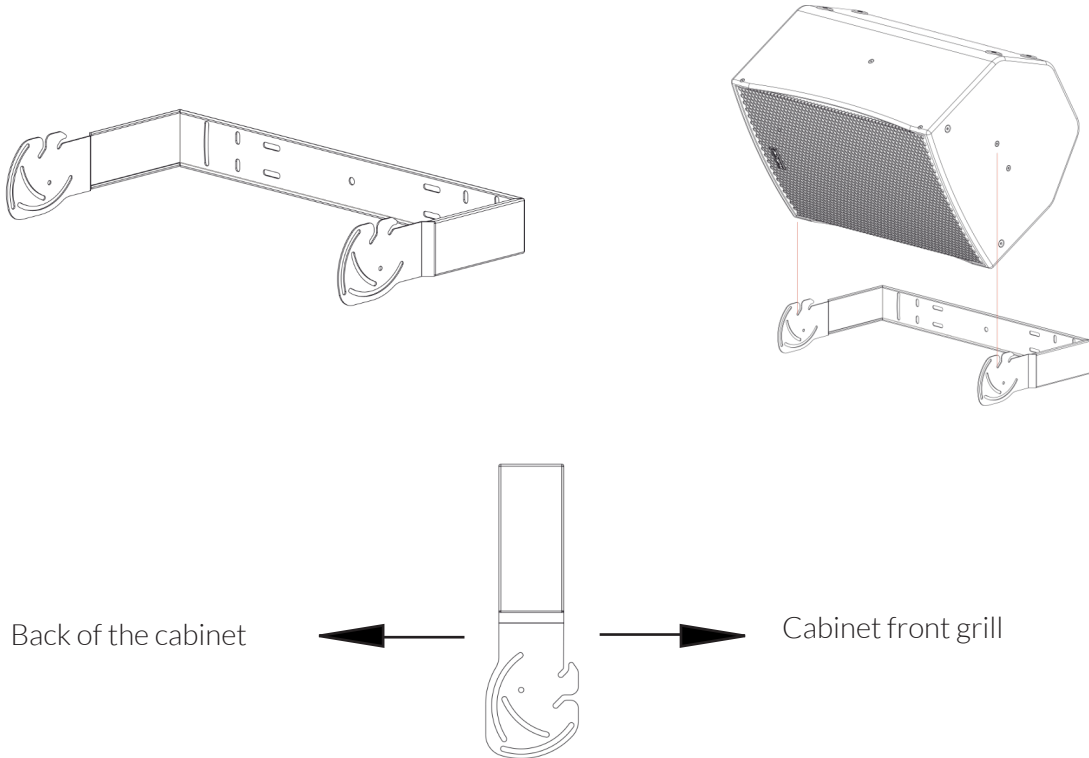

- **How to use it?**

Before starting with the installation please note that the UBR bracket offers three different options and you have to select one of them before installing the support. Simply check the following drawings and select the best option in order to achieve the coverage required.

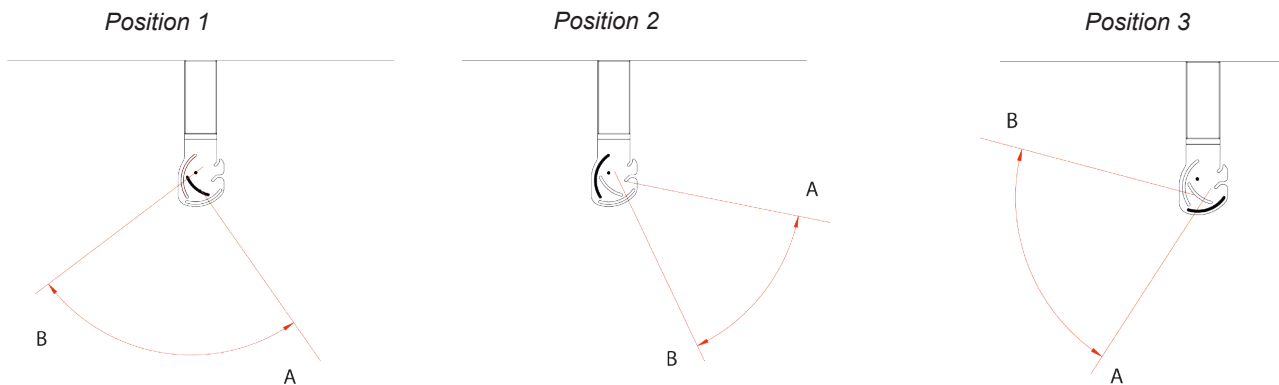

The angles show the different variations available (from A to B) in order to fix the center of the cabinet (front grill). Please pay special attention to the optimal positioning of your cabinet.

## HOW TO USE ACCESSORIES FOR INSTALLATION

Once your selection is made (Position 1, 2 or 3) then you can start with the installation.

The first thing to do is to fix the UBR support in the place required (ceiling, wall, floor, etc).

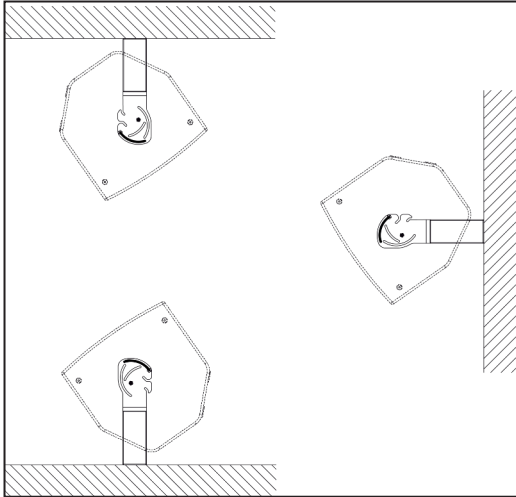

Always check the suspension point is secure and free of excess weight, vibration, etc. And be careful where the cabinets are suspended from.

Before fixing it completely please check that the position of the bracket is correct. Remember where the front side is. If everything is correct then you can fix the UBR support (without the cabinet).

It is very important to ensure that the support is strongly fixed. Please always check it. Never place the safety of personnel at risk.

Once the UBR support is ready then you have to prepare the cabinet. You need to make some changes in order to hook the enclosure from the U type bracket. See below.

Please have a look at the top and bottom of your cabinet. You will find 2 screws in the middle of the top and another two screws in the middle of the bottom. Just remove these shorts screws. You will use these holes to fix the cabinet to the UBR support, using the longer screws provided with the support kit.

If your Lynx Pro Audio cabinet is equipped with a pole mount support then just remove 2 screws of the pole mount support (only 2) and use these holes to fix the UBR support.

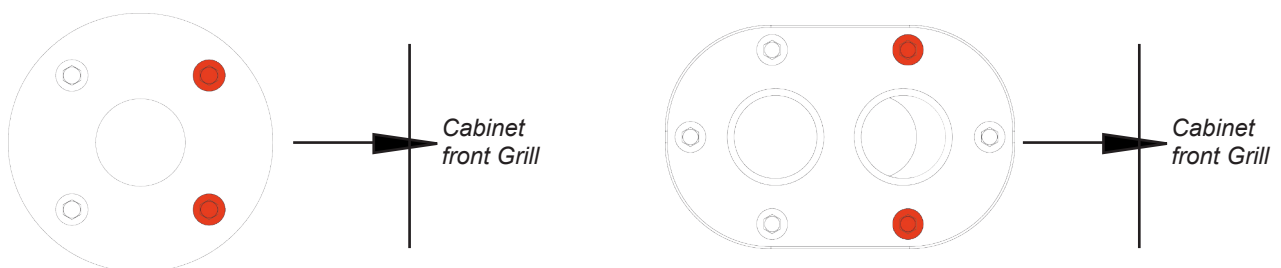

Now you have 2 holes available per side (top and bottom) without removing the pole mount support. And you can use the holes available to fix the cabinet to the UBR support.

Only use the special screws provided with the support kit.

## HOW TO USE ACCESSORIES FOR INSTALLATION

Now that everything is clear we can start with the installation of the cabinet. We recommend the use of the Position 1 or Position 2, and this is how to proceed:

Position 1

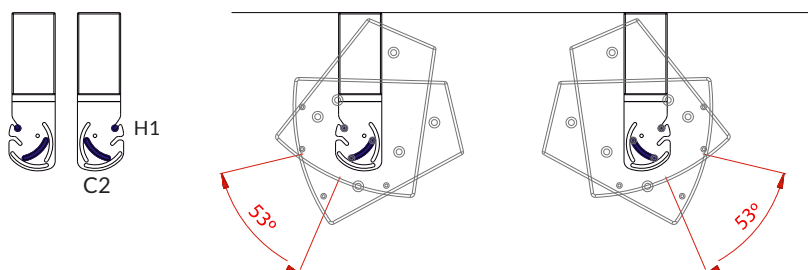

Position 2

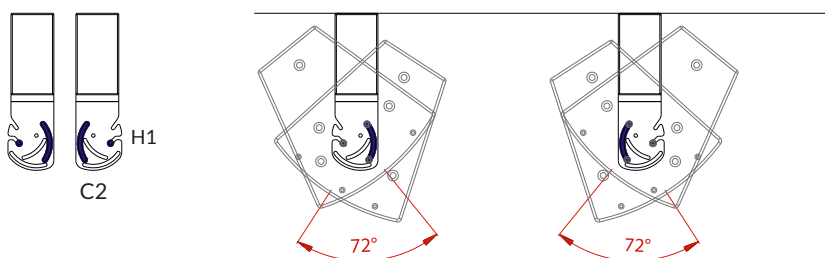

If you choose Position 1 or Position 2 you will have to insert two special fixing screws into the cabinet (one per side) before installing the enclosure.

So firstly, take 2 of the fixing screws provided and insert them into your cabinet. Where? Have a look. Seeing the cabinet in horizontal position simply insert one fixing screw in the UPPER HOLE of each side (left/right), but don't insert it completely. Just keep 5 mm out of the insert. These screws will help you to hook up the cabinet from the UBR support in order to start with the cabinet installation.

Once the 2 screws are inserted (keeping 5 mm free) into the enclosure (one per side) then you can hook up the cabinet (from the 5 mm free screws) into the UBR support. See the point H1 in the drawing of your choice (Position 1 or 2). Just hook the cabinet placing the screws into the points H1 at both sides of the bracket. Do not fix them completely at the moment. You will do it when the cabinet is in the desired position.

Now you have to use the appropriate curve groove of the UBR support in order to slide the other fixing screw per side and orientate the cabinet. See the curve C2 in the drawing of your choice (Position 1 or 2). Just insert the special screw in the appropriate curve and match the thread insert of the cabinet. You must do it on both sides of the cabinet. Do not fix them completely at the moment just keep 5 mm free so you can guide the enclosure carefully to achieve the correct coverage.

When the cabinet is in the desired position then tighten the four screws (2 per side) and the cabinet will be correctly installed.

## HOW TO USE ACCESSORIES FOR INSTALLATION

This is how to proceed in order to install the UBR in Position 3:

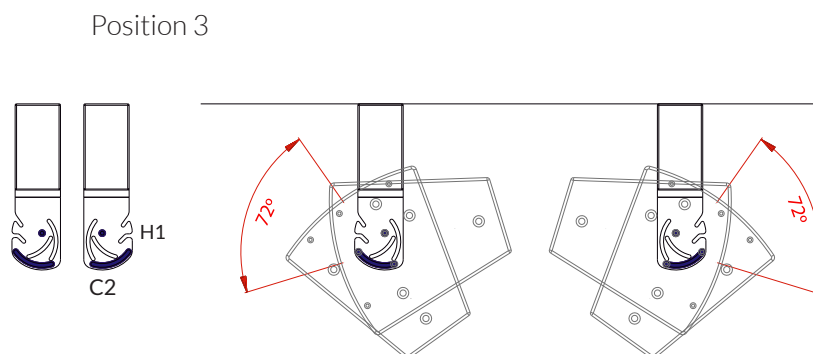

First, you need to have the 4 special fixing screws in your hand/pocket (none in the enclosure). Seeing the cabinet in horizontal position you will use the UPPER HOLE of each side (left/right) to insert one special screw per side, but you won't insert them now.

Before inserting the screws you have to hold the cabinet into the UBR bracket and match the UBR hole (see drawing point 1) with the thread insert of your cabinet. Once hole 1 and the thread insert match then you can insert the special screw (one per side). Don't fix the screw now, just keep 5 mm out of the insert.

Now you have to use the appropriate curve groove of the UBR support in order to slide the other fixing screw per side and orientate the cabinet. See the curve C2 in the drawing. Just insert the special screw in this curve and match the thread insert of the cabinet. Do not fix them completely at the moment just keep 5 mm free so you can guide the enclosure carefully to achieve the correct coverage.

When the cabinet is in the desired position then tighten the four screws (2 per side) and the cabinet will be correctly installed.

## RAINBOW 3D Acoustic Prediction Software

Lynx Pro Audio's R&D department is working on Rainbow 3D, a new acoustic simulation software with dynamic 3D features. With a sophisticated design, Rainbow 3D stands out for its speed, being able to provide a simulation in just a few seconds. It also provides algorithms for beam steering and optimizing the listening area.

- **Designed from scratch by professionals**

Rainbow 3D has been programmed from scratch by Lynx Pro Audio engineers, using new programming procedures that achieve an effective simulation with really low calculation time.

- **Multiple listening zones**

The program can simulate all Lynx Pro Audio's acoustic enclosures located in a 3D space, including the classic side, top and front views. It can also define multiple listening zones and allows offset positioning and symmetry. Blueprint images, textures and PNG format pictures can be imported.

- **Unlimited sound sources**

Allows the acoustic simulation for an unlimited number of sound sources and audio systems. You can place as many systems (subwoofers, line arrays, columns and individual boxes) as you desire. Also, the line arrays can be placed in stack or flown configuration.

- **Beam steering**

Rainbow 3D has the ability to add DSP processing to the simulation and uses algorithms to control the directivity (beam steering) in columns, without the need to tilt them physically, being able to divide the column into several beams that point to different zones.

- **Accurate optimization thanks to FIR filters**

Optimized algorithms are used in the listening area to improve the sound coverage and the frequency response. This feature can be executed in a matter of seconds. Additionally, the export of FIR coefficients can be performed with the optimization for later loading in the DSP via Ethernet or a USB device. In the near future direct communication with Lynx Pro Audio and OCS will be available.

- **Multiple measures and tools**

Likewise, the R&D department is developing multiple measurement and analysis tools for the calculated data. For example, the sound pressure curves (SPL) in the listening areas and the capture of virtual measurements that show the frequency response in the points of location indicated and added. Among other tools you will find autosplay and a wizard to set up different subwoofer arrangements.

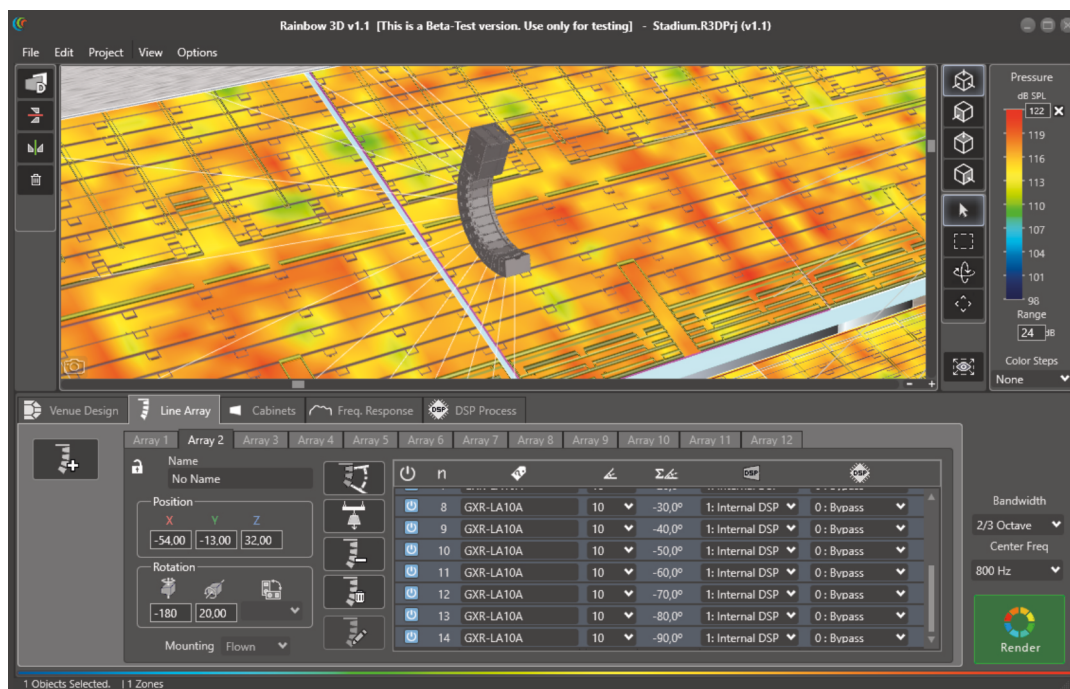



## DECLARATION OF CONFORMITY

**Lynx Pro Audio S.L.**  
Calle 1 - Pol. Ind. Picassent  
46220 Picassent (Valencia)  
SPAIN - EU  
Tel.: (+34) 961 10 96 01  
[www.lynxproaudio.com](http://www.lynxproaudio.com)

Lynx Pro Audio S.L. declares that ionic series are in conformity with the following EC directives:

Low Voltage Directive	2006/95/EC
Electromagnetic Compatibility EMC	2004/108/EC
RoHS Directive	2002/95/EC

In accordance with Harmonized European Norms:

EN 60065:2002	Audio, video and similar electronic apparatus. Safety requirements
EN 55032:2012	Electromagnetic compatibility of multimedia equipment. Emission requirements.
EN 55103-1:1996	Electromagnetic compatibility. Product family standard for audio, video, audiovisual and entertainment lighting control apparatus for professional use. Part 1: Emission.
EN 55103-2:1996	Electromagnetic compatibility. Product family standard for audio, video, audiovisual and entertainment lighting control apparatus for professional use. Part 2: Immunity.
KR models:	KR-10 / KR-12





## LYNX PRO AUDIO GUARANTEE

Lynx products are guaranteed against every kind of manufacturing fault 3 year after the date of sale. When products are under guarantee, the repairing and the free supplying of the device parts in order to correct any kind of defect are guaranteed by Lynx Pro Audio S.L. In the case that the product could not be returned to the factory for checking and repairing, Lynx Pro Audio S.L. would supply all the necessary parts.

Lynx Pro Audio S.L. is not responsible for any damage or defect caused during the transport or caused by an undue or improper handling by a non-authorized person during the life of this guarantee.

All our products undergo rigorous tests and quality controls. We guarantee the characteristics described here within and their quality against any fabrication defect.

The user loses all warranty rights if he incorporates or carries out any modification to the product, if he uses it outside of the stated safe working loads or does not secure the system properly using all the pins in their corresponding holes.

For any question regarding the product, the user must quote the model and serial number.

**WEEE Declaration:** Electrical and electronic equipment must be disposed of separately from normal waste at the end of its operational lifetime. Please dispose of this product according to the respective national regulations or contractual agreements. If there are any further questions concerning the disposal of this product please contact Lynx Pro Audio S.L.