

Ionic series

USER MANUAL

IONIC-5CXv

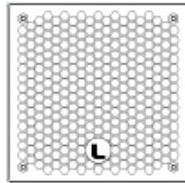

Lynx Pro Audio S.L.



IONIC-5CXv

Manufacturer



LYNX Pro Audio S.L.
Calle 1 - Pol. Ind. Picassent
E-46220 Picassent (Valencia)



CE CERTIFICATION, EUROPEAN PRODUCT

This user guide is property of Lynx Pro Audio S.L. Any reproduction of this manual, by any means is strictly prohibited. Copyright 2020. All rights reserved.

INTRODUCTION

This manual describes the recommended installation procedure for the Ionic-5CX.

The Ionic-5CXv is a passive coaxial speaker for outdoor use and part of the Ionic series. The Ionic cabinets are compact, modular and powerful and the complete series also includes two sub units and two column models.

Weight has been left as low as possible providing easy set ups in fixed installation as well as easy transport for portable applications. The Ionic-5CXv is powered from the subwoofer unit Ionic-12S which includes a Digital Signal Processor offering different presets to cover a wide range of sound applications. It can also be powered from an external amplifier using the ARK optimised preset.

Please note that a wide range of mounting accessories is available.

CONTENTS

• SAFETY PRECAUTIONS	4
• SYSTEM OVERVIEW	
IONIC-5CXv	5
• CONNECTORS AND CONNECTIONS	6
• AMPLIFICATION	8
• CONFIGURING THE DIGITAL SIGNAL PROCESSOR	10
• ONLINE CONTROL SYSTEM	12
• RAINBOW 3D ACOUSTIC SIMULATION SOFTWARE	13
• HARDWARE AND ACCESSORIES	14
• CERTIFICATIONS AND GUARANTEE	15

Before starting to use this device, please read this instruction manual carefully.
Keep these instructions in the place where the equipment will be used and with easy access to them.



• **Electrical appliance**

The exclamation mark within a triangle identifies the presence of electricity. Use the system carefully without wet hands or feet. Avoid installing the speaker in wet or excessively humid places. Do not place material that contains liquid on or near the unit. Avoid dripping or splashing water or any liquid over the unit. Regularly check the condition of the cables and make sure these are not being walked on or pinched. Connect the speaker to bipolar, earthed mains. The mains plug must be connected to the appropriate protection (fuse or breaker). Connection to any other type of mains could result in an electrical shock and violate local electrical codes.

CAUTION: DO NOT CONNECT OR DISCONNECT THE AC POWER CONNECTORS UNDER LOAD.



• **Heavy equipment**

Apply back protection when using the system. Avoid loading and unloading at heights.



• **Electrical shock risk**

The diagonal mark within a triangle identifies the presence of dangerous voltage.

Do not open or handle the interior of the box. These parts are not to be adjusted by the user. For maintenance and/or repair please go to an authorized service centre. In order to reduce the risk of electric shock, disconnect from AC before plug in or unplugging Audio signal cables. Reconnect to AC only if all signal connections are made and secured. Never manipulate the ground type plug provided.

The AC mains plugs should always remain accessible for operation.

Unplug the loudspeaker during storms or when it's being used for a long time.



• **Hearing damage risk**

These systems can reproduce large quantities of sound pressure which can damage hearing. Take precautions if you are going to be near them for extended amounts of time and do not get too close.



• **Hanging / Flying**

Do not hang the cabinets from the handles or from any other part other than the designated hanging point. When flying this system please observe the technical and "Rainbow" software data carefully. Never exceed the maximum safe working loads or ignore the instructions included within this manual. Use Only flying accessories provided by Lynx Pro Audio S.L. Rigging must be always carried out by professionals.



• **Delicate Material**

Please ensure no foreign object or water enters the speaker. Only clean the unit with dry cloths. Do not use solvents.



• **Overheating / Fire risk**

To reduce the risk of the speaker over heating, avoid direct contact with sunlight. Avoid placing the unit close to heat inducing objects such as radiators. Do not cover the equipment in use and do not block any ventilation openings. Do not put naked flame, such as lighted candles, close or on top of the unit.



• **Electromagnetic and interferente emissions**

Avoid placing objects which through electromagnetic waves can damage the unit, such as mobile phones, lap tops, magnetic strip cards etc.

This system complies with normatives

EN 55103-1 (1)

EN 55103-2 (2)

(1) This device may not cause harmful interferences.

(2) This device may receive interference including interferences that may cause undesired working.



• **IMPORTANT NOTE**

This Equipment must be used in accordance with these instructions and by trained professional personnel only. This equipment should not be used in places with extreme tropical climates. Don't expose this apparatus to extreme humidity and or temperature values.

SYSTEM OVERVIEW

- Ionic-5CXv

Weather-resistant loudspeaker. Compact & versatile, easy to use, easy to install. 5" coaxial speaker offering a coverage of 70° conical dispersion and 117dB SPL. 100 W autoformer / selectable 8 Ω or 100 V.

- Technical Data:

Components:	1 x 5" coaxial speaker with LF 1.5" and HF 1" voice coil
Frequency range:	64 Hz – 20 KHz (-10dB)
Frequency response:	90 Hz – 20 KHz (± 3dB)
Sensitivity	93 dB (1W@1m)
Max SPL / Peak:	114 dB - 120 dB peak
Coverage:	70° conical dispersion
Power:	150 W (300 W program, 600 W peak)
Operating mode:	8 Ω / 100 V: 100 W / 75 W / 50 W selectable
Connectors:	In: Euroblock terminal Out: Cable gland
Finish:	Polyurea coating
Material:	10 mm premium birch plywood
Dimensions:	140 x 140 x 220 mm (H x W x D)
Weight:	3 Kg (6.6 lbs)

- Ionic-5CXv measurements

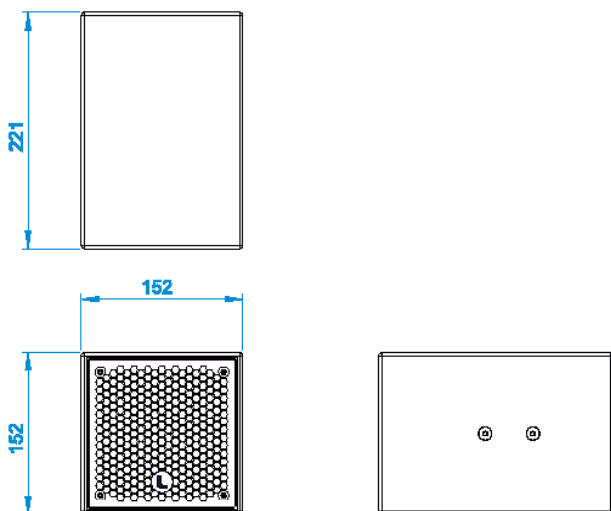

- Ionic-5CXv back panel

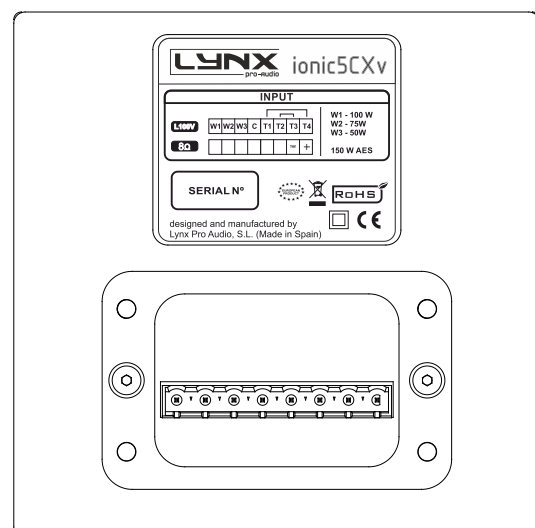

CONNECTORS AND CONNECTIONS

- Normative

The cabinet meet the following standards:

EN 60065:2014	Audio, video and similar electronic apparatus. Safety requirements
EN 55032:2012	Electromagnetic compatibility of multimedia equipment. Emission requeriments.
EN 55103-2:2009	Electromagnetic compatibility. Product family standard for audio, video, audiovisual and entertainment lighting control apparatus for professional use. Part 2: Immunity.
EN 50581:2012	Technical documentation for the assessment of electrical and electronic products with respect to the restriction of hazardous substances

The Ionic-5CXv is in conformity with the following EC directives:

Low Voltage Directive	2014/35/UE
Electromagnetic Compatibility EMC	2014/30/UE
RoHS Directive	2011/65/UE
RAEE (WEEE)	2012/19/UE

- Connectors

The Ionic-5CX have a connection panel at the rear of the cabinet. First, choose the operating mode: 8Ω or 100V.

For 8Ω:

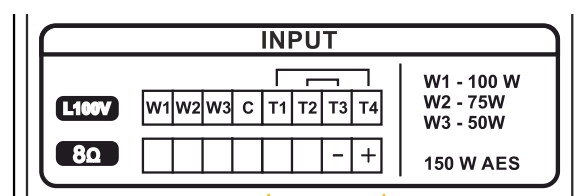

Euroblock 1

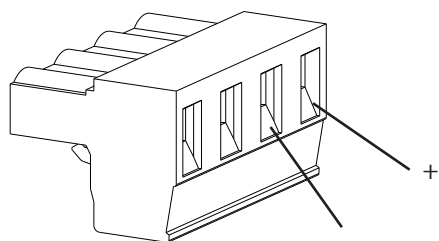

Euroblock 1

If you use 8Ω you need to connect the Euroblock terminal to the right side. Then, connect the red cable to the positive and the black cable to the negative.

For 100V:

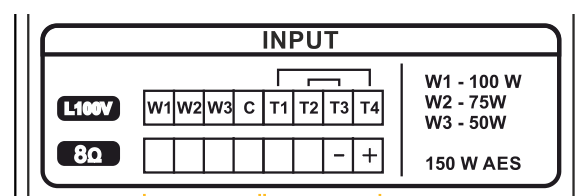

Euroblock 1 Euroblock 2

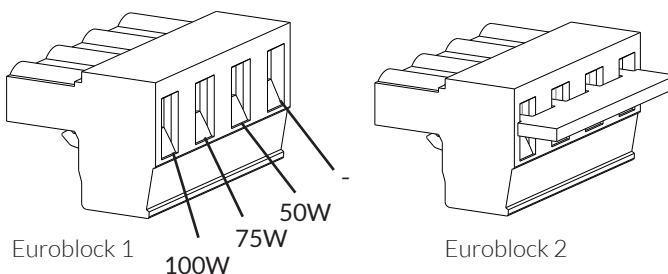

In case you want 100V, you must connect the two Euroblock terminals as the picture above (Euroblock 1 on the right, Euroblock 2 on the left). On the Euroblock 1, you have to connect the black cable to the negative connection and the red cable to the power you want to use: 100W, 75W or 50W.

CONNECTORS AND CONNECTIONS



Important note:

To guarantee the perfect sealing and the functioning of the connections, it is essential that the back panel is screwed with the cable gland. If this back panel is removed, the box will no

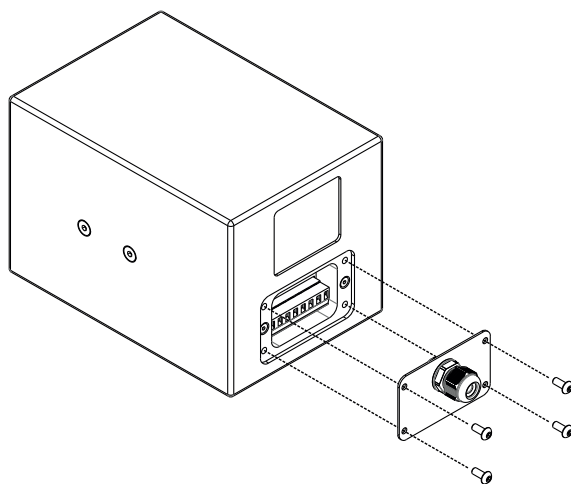

• Recommendations

Always ensure cables are in good condition. Know the recommended cable length and thickness according to the cabinet and quantity you are installing. An incorrect connection can affect the functioning of the system or even damage it. Cable thickness will vary according to cabinet impedance, quantity and distance. This is especially important when connecting Subwoofers.

As a guide, please see the following table which outlines the thickness depending on the power and length of cable.

Maximum recommended cable length for low impedance systems						
Wire section	AWG number	Cable resistance in 100 meters	Maximum recommended length (in meters)			
			2 Ω	4 Ω	8 Ω	16 Ω
13.3 mm ²	6	0.25 Ω	24	57	122	253
6.63 mm ²	8	0.49 Ω	12	28	61	126
5.26 mm ²	10	0.62 Ω	10	23	48	100
3.31 mm ²	12	0.99 Ω	6	14	30	63
2.08 mm ²	14	1.57 Ω	4	9	19	40
1.31 mm ²	16	2.49 Ω	2	6	12	25
0.82 mm ²	18	3.98 Ω	2	4	8	16
0.52 mm ²	20	6.28 Ω	1	2	5	10
0.33 mm ²	22	9.89 Ω	1	1	3	6

Bear in mind Ohm ratings on the amplifiers used to power the cabinets. For example, 2 ohm amplifier configurations are not recommended due to the excessive power from the amp output.

Never connect more cabinets than recommended in parallel. With parallel connections, the total impedance can be calculated by dividing the impedance of 1 cabinet by the number connected.

AMPLIFICATION

The Ionic-5CXv is very easy to use. The installation can be done using external amplifiers or in combination with the powered subwoofers Ionic-12S and Ionic-18S.

When using the Ionic-5CXv powered by our Ionic active subwoofers you can use various preset configurations available from the integrated DSP.

- Using the Ionic powered subwoofers

The Ionic-5CXv can be powered from the active subwoofers Ionic-12S or Ionic-18S in different configuration systems. You can use 2 cabinets in combination with one subwoofer Ionic-12S or use 4 cabinets with one subwoofer Ionic-18S.

- Back panel

In the following drawing you can see the back panel of the subwoofer Ionic-12S (very similar to Ionic-18S), which includes the power amplification and the digital signal control board. From this back panel you can also select various preset configurations using the LCD display and digital control buttons.

* Available when the user has requested the cabinets to be supplied with the Ethernet Module kit.

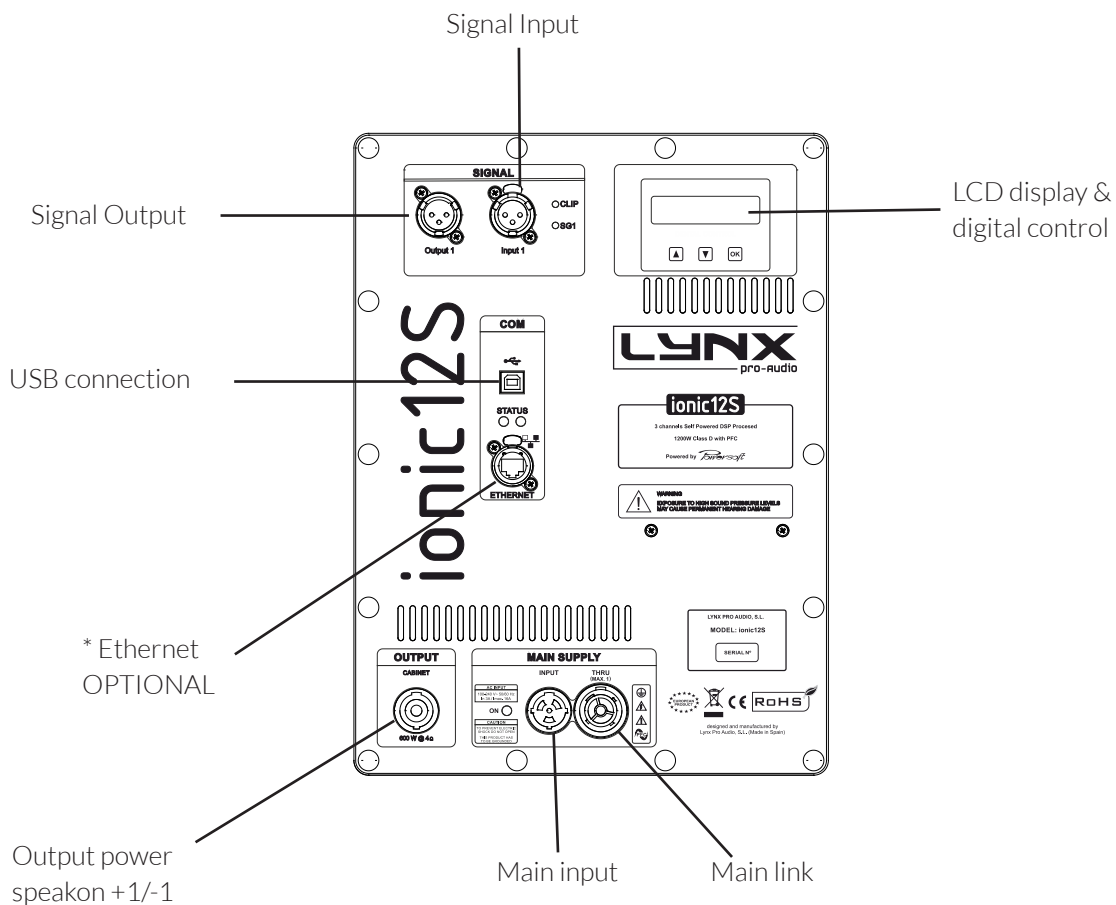

* Available when the user has requested the cabinets to be supplied with the Ethernet Module kit.

CONNECTORS AND CONNECTIONS

- Signal and connectors for Ionic powered subwoofers

SOCKET POWERCON TRUE1

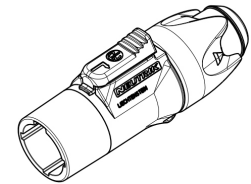
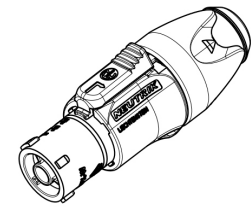
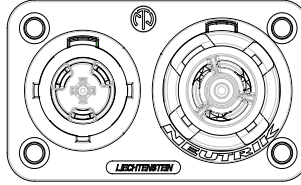

XLR SOCKET CONNECTORS

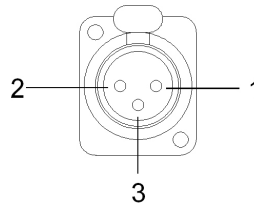

- INPUTS**
 1.- EARTH
 2.- LIVE (+)
 3.- LIVE (-)

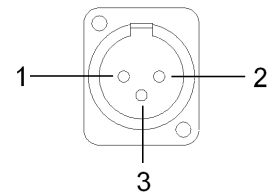

CONFIGURATION PANEL

On the Ionic subwoofers back panel you will see 3 buttons and an information screen, on which you can read the established parameters and information such as amplification module temperature, input signal level and name of the current preset (Fig1).

If changes are not made the display will automatically dim to save energy and avoid unnecessary light in situations where light is not wanted. To re-activate the light simply press the OK button.

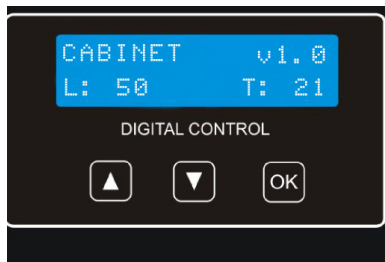

Fig 1

From the buttons below the display you can change the preset or select the input digital or analog. You can see how to proceed on next page.

For ionic systems you can find different preset configurations in mono and stereo.

You can change the EQ of any preset but this change will not be saved in the preset, therefore as soon as you change preset the EQ will be restarted. For example, if you want to use PRESET 1 but you prefer to change the EQ, you connect the cabinet to your computer via USB or Ethernet and introduce the EQ changes using the Online Control System software. Then you will be able to use your own EQ in PRESET 1 day after day only if you don't change to another preset. Once you change the preset the DSP restarts with the manufacturer settings. So if you change from PRESET 1 to PRESET 2 and then come back to PRESET 1 you will find that the PRESET 1 has the manufacturer's EQ again.

Note:

You must apply the desired configuration in each ionic subwoofer cabinet. Just select on the screen the cabinet ionic-5CX with the preset configuration desired.

This operation requires electrical power to work.

HOW TO SELECT THE INPUT: DIGITAL OR ANALOG

This selection is only available when the user has requested the subwoofers to be supplied with the Digital input kit. There are four input options: Analog / Digital L / Digital R / Digital L+R

To select the input mode just press the OK button (3) and the up button (1), both at the same time but pressing the OK button first. Then you can select one of the four options using the up button (1).

To confirm your selection press OK (3) until the progress bar finishes.

The display will show an inverted D (digital) or an inverted A (analog) so you can always know if the input is digital or analog.

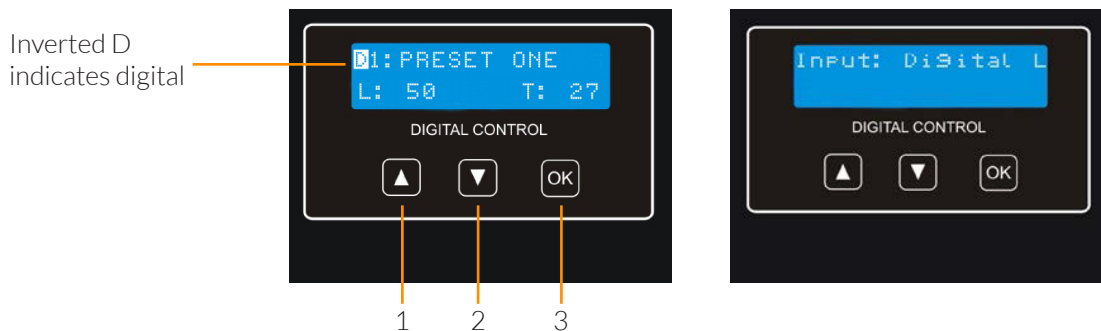

SELECT AND RUN PRESET

To change the preset configuration (see Fig 2) just press the up button (1) and down button (2) until you see the title and preset number required and once found press OK (3) until the progress bar finishes (Fig 3). The display will indicate "Loading DSP" (Fig 4)

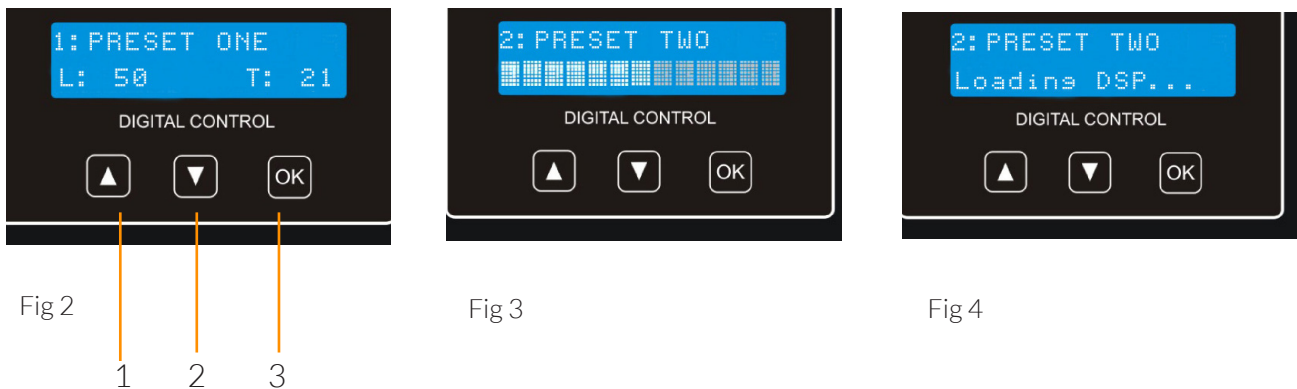

Note:

In case of a power cut, the DSP will save its last configuration when restarted.

ONLINE CONTROL SYSTEM

- Who is it for?

Users of Self powered DSP incorporated Lynx Pro Audio Cabinets where the user has requested the cabinets be supplied with the Ethernet Module kit.

- What is it for?

Obtain detailed information of cabinet behaviour and monitor the cabinet/s in real time. You can change the preset, gain, mute, polarity and phase. You can also activate the air absorption compensation and select the «SOLO» mode.

- How does it work?

Via Ethernet (cable or wireless). Once installed, the O.C.S. software automatically detects all the cabinets connected to the network and displays them in the O.C.S. window on the users PC.

- What does it show?

As well as displaying the cabinet model and IP address the O.C.S will be monitoring in real time and the user will be able to view RMS levels, Input clip, power module temperature, compression levels, air absorption compensation and cabinet angulation.

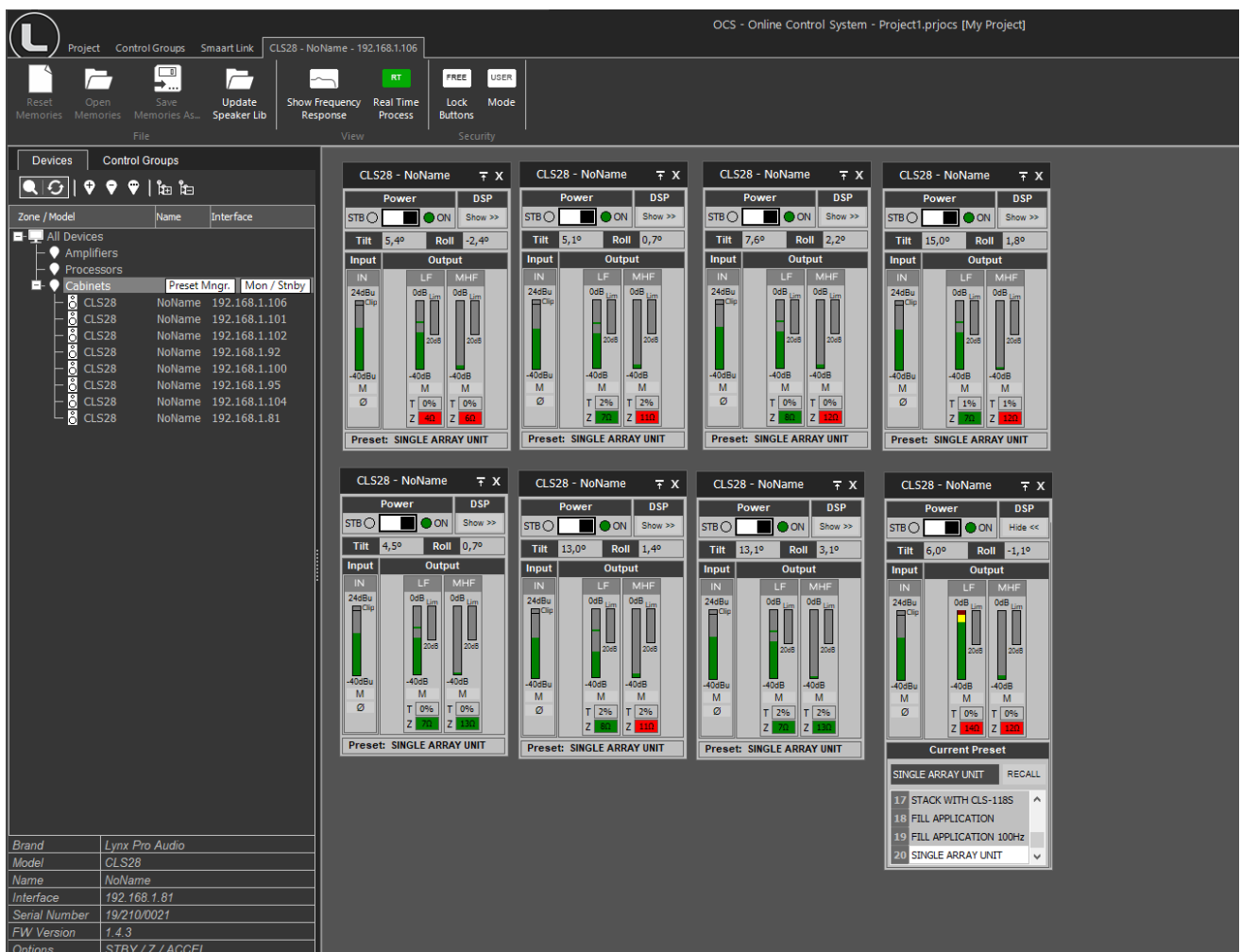

RAINBOW 3D Acoustic Prediction Software

Lynx Pro Audio's R&D department is working on Rainbow 3D, a new acoustic simulation software with dynamic 3D features. With a sophisticated design, Rainbow 3D stands out for its speed, being able to provide a simulation in just a few seconds. It also provides algorithms for beam steering and optimizing the listening area.

- **Designed from scratch by professionals**

Rainbow 3D has been programmed from scratch by Lynx Pro Audio engineers, using new programming procedures that achieve an effective simulation with really low calculation time.

- **Multiple listening zones**

The program can simulate all Lynx Pro Audio's acoustic enclosures located in a 3D space, including the classic side, top and front views. It can also define multiple listening zones and allows offset positioning and symmetry. Blueprint images, textures and PNG format pictures can be imported.

- **Unlimited sound sources**

Allows the acoustic simulation for an unlimited number of sound sources and audio systems. You can place as many systems (subwoofers, line arrays, columns and individual boxes) as you desire. Also, the line arrays can be placed in stack or flown configuration.

- **Beam steering**

Rainbow 3D has the ability to add DSP processing to the simulation and uses algorithms to control the directivity (beam steering) in columns, without the need to tilt them physically, being able to divide the column into several beams that point to different zones.

- **Accurate optimization thanks to FIR filters**

Optimized algorithms are used in the listening area to improve the sound coverage and the frequency response. This feature can be executed in a matter of seconds. Additionally, the export of FIR coefficients can be performed with the optimization for later loading in the DSP via Ethernet or a USB device. In the near future direct communication with Lynx Pro Audio and OCS will be available.

- **Multiple measures and tools**

Likewise, the R&D department is developing multiple measurement and analysis tools for the calculated data. For example, the sound pressure curves (SPL) in the listening areas and the capture of virtual measurements that show the frequency response in the points of location indicated and added. Among other tools you will find autoplay and a wizard to set up different subwoofer arrangements.

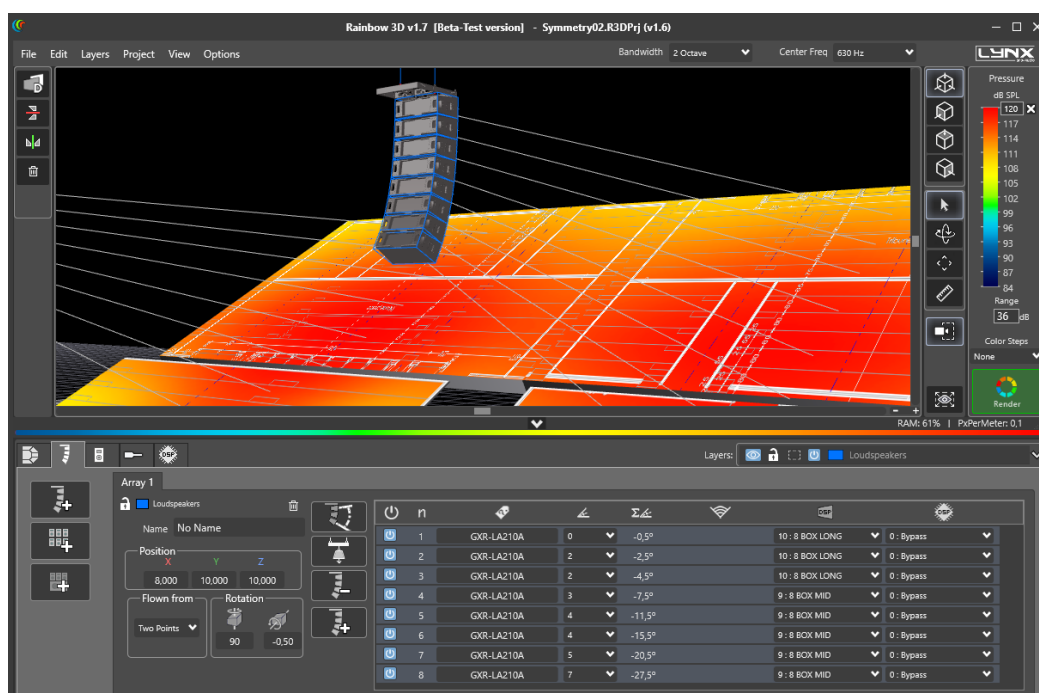

HARDWARE AND ACCESSORIES

The Ionic cabinets offer a variety of practical accessories to help use the system in a number of applications.

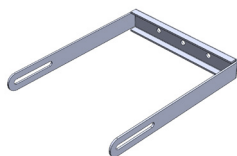

UBR-5CX
Wall bracket for the
Ionic-5CX



DECLARATION OF CONFORMITY

Lynx Pro Audio S.L.
Calle 1 - Pol. Ind. Picassent
46220 Picassent (Valencia)
SPAIN - EU
Tel.: (+34) 961 10 96 01
www.lynxproaudio.com

Lynx Pro Audio S.L. declares that ionic series are in conformity with the following EC directives:

Low Voltage Directive	2006/95/EC
Electromagnetic Compatibility EMC	2004/108/EC
RoHS Directive	2002/95/EC

In accordance with Harmonized European Norms:

EN 60065:2002	Audio, video and similar electronic apparatus. Safety requirements
EN 55103-1:1996	Electromagnetic compatibility. Product family standard for audio, video, audiovisual and entertainment lighting control apparatus for professional use. Part 1: Emission.
EN 55103-2:1996	Electromagnetic compatibility. Product family standard for audio, video, audiovisual and entertainment lighting control apparatus for professional use. Part 2: Immunity.
Ionic models:	Ionic-50 / Ionic-100 / Ionic-18S / Ionic-12S / Ionic-5CX / Ionic-5CXv



LYNX PRO AUDIO GUARANTEE

Lynx products are guaranteed against every kind of manufacturing fault 3 year after the date of sale. When products are under guarantee, the repairing and the free supplying of the device parts in order to correct any kind of defect are guaranteed by Lynx Pro Audio S.L. In the case that the product could not be returned to the factory for checking and repairing, Lynx Pro Audio S.L. would supply all the necessary parts.

Lynx Pro Audio S.L. is not responsible for any damage or defect caused during the transport or caused by an undue or improper handling by a non-authorized person during the life of this guarantee.

All our products undergo rigorous tests and quality controls. We guarantee the characteristics described here within and their quality against any fabrication defect.

The user loses all warranty rights if he incorporates or carries out any modification to the product, if he uses it outside of the stated safe working loads or does not secure the system properly using all the pins in their corresponding holes.

WEEE Declaration: Electrical and electronic equipment must be disposed of separately from normal waste at the end of its operational lifetime. Please dispose of this product according to the respective national regulations or contractual agreements. If there are any further questions concerning the disposal of this product please contact Lynx Pro Audio S.L.