

Ionic series

USER MANUAL

IONIC-100
IONIC-18S

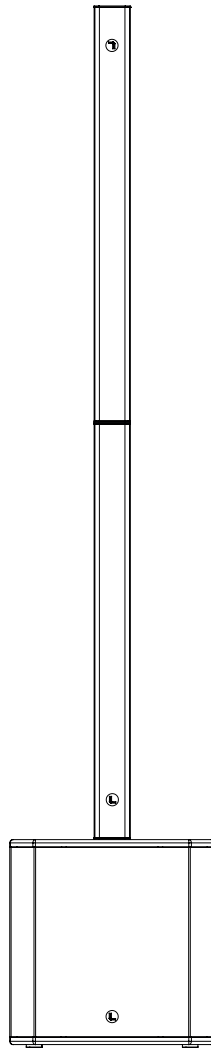

Lynx Pro Audio S.L.



IONIC-100



IONIC-18S

Manufacturer



LYNX Pro Audio S.L.
Calle 1 - Pol. Ind. Picassent
E-46220 Picassent (Valencia)



CE CERTIFICATION, EUROPEAN PRODUCT

INTRODUCTION

This manual describes the recommended installation procedure for the Ionic-100 in combination with the subwoofers Ionic-18S.

The Ionic series is Lynx Pro Audio's answer to light, portable and permanent column speakers. The Ionic series comprise two full-range modular columns (Ionic-100 and Ionic-50), one small coaxial cabinet (Ionic-5CX) and two subwoofers (Ionic-18S and Ionic-12S).

The columns are very low profile, versatile, aesthetically pleasing and are designed for reverberant installations where intelligible, clear voice reproduction is paramount and where a low profile, discreet column is required. They are very easy to install and can be done so either horizontally or vertically.

The full range columns can be powered from the active subwoofers and also offer various preset configurations from the integrated DSP.

Please note that a wide range of mounting accessories is available.

CONTENTS

• SAFETY PRECAUTIONS	4
• SYSTEM OVERVIEW	
IONIC-100	5
IONIC-18S	6
BACK PANEL	7
• CONNECTORS AND CONNECTIONS	8
ACOUSTIC CENTRE	9
CONNECTION EXAMPLE PRESET 1	10
CONNECTION EXAMPLE PRESET 2	11
CONNECTION EXAMPLE PRESET 3	12
• CONFIGURING THE DIGITAL SIGNAL PROCESSOR	13
• ONLINE CONTROL SYSTEM	15
• RAINBOW 3D ACOUSTIC SIMULATION SOFTWARE	16
• WALL INSTALLATION	17
• HARDWARE AND ACCESSORIES	18
• CERTIFICATIONS AND GUARANTEE	19

Before starting to use this device, please read this instruction manual carefully. Keep these instructions in the place where the equipment will be used and with easy access to them.



• **Electrical appliance**

The exclamation mark within a triangle identifies the presence of electricity. Use the system carefully without wet hands or feet. Avoid installing the speaker in wet or excessively humid places. Do not place material that contains liquid on or near the unit. Avoid dripping or splashing water or any liquid over the unit. Regularly check the condition of the cables and make sure these are not being walked on or pinched. Connect the speaker to bipolar, earthed mains. The mains plug must be connected to the appropriate protection (fuse or breaker). Connection to any other type of mains could result in an electrical shock and violate local electrical codes.
CAUTION: DO NOT CONNECT OR DISCONNECT THE AC POWER CONNECTORS UNDER LOAD.



• **Heavy equipment**

Apply back protection when using the system. Avoid loading and unloading at heights.



• **Electrical shock risk**

The diagonal mark within a triangle identifies the presence of dangerous voltage. Do not open or handle the interior of the box. These parts are not to be adjusted by the user. For maintenance and/or repair please go to an authorized service centre. In order to reduce the risk of electric shock, disconnect from AC before plug in or unplugging Audio signal cables. Reconnect to AC only if all signal connections are made and secured. Never manipulate the ground type plug provided. The AC mains plugs should always remain accessible for operation. Unplug the loudspeaker during storms or when it's being used for a long time.



• **Hearing damage risk**

These systems can reproduce large quantities of sound pressure which can damage hearing. Take precautions if you are going to be near them for extended amounts of time and do not get too close.



• **Hanging / Flying**

Do not hang the cabinets from the handles or from any other part other than the designated hanging point. When flying this system please observe the technical and "Rainbow" software data carefully. Never exceed the maximum safe working loads or ignore the instructions included within this manual. Use Only flying accessories provided by Lynx Pro Audio S.L. Rigging must be always carried out by professionals.



• **Delicate Material**

Please ensure no foreign object or water enters the speaker. Only clean the unit with dry cloths. Do not use solvents.



• **Overheating / Fire risk**

To reduce the risk of the speaker over heating, avoid direct contact with sunlight. Avoid placing the unit close to heat inducing objects such as radiators. Do not cover the equipment in use and do not block any ventilation openings. Do not put naked flame, such as lighted candles, close or on top of the unit.



• **Electromagnetic and interferente emissions**

Avoid placing objects which through electromagnetic waves can damage the unit, such as mobile phones, lap tops, magnetic strip cards etc.

This system complies with normatives

EN 55103-1 (1)

EN 55103-2 (2)

(1) This device may not cause harmful interferences.

(2) This device may receive interference including interferences that may cause undesired working.



• **IMPORTANT NOTE**

This Equipment must be used in accordance with these instructions and by trained professional personnel only. This equipment should not be used in places with extreme tropical climates. Don't expose this apparatus to extreme humidity and or temperature values.

SYSTEM OVERVIEW

- Ionic-100

The Ionic-100 is a passive column speaker. It uses 12 x 3" (0.75" voice coil) neodymium transducers offering a coverage of 15° +/- 5° V x 100° H and 121dB SPL.

- Technical Data:

Components:	12 x 3" speaker with 0.75" voice coil
Frequency range:	150 Hz – 20 KHz (-10dB)
Frequency response:	180 Hz – 18 KHz (± 3dB)
Sensitivity	96 dB (1W@1m)
Max SPL / Peak:	121 dB - 127 dB peak
Coverage:	15° ± 5° V x 100° H
Power:	300 W (600 W program, 1200 W peak)
Nominal impedance:	8 Ω
Connectors:	2 x Neutrik Speakon NL4MP
Finish:	Epoxy paint / bespoke pattern
Material:	1.5 mm stainless steel
Dimensions:	1000 x 89 x 117 mm (H x W x D)
Weight:	13 Kg (29 lbs)

- Ionic-100 measurements

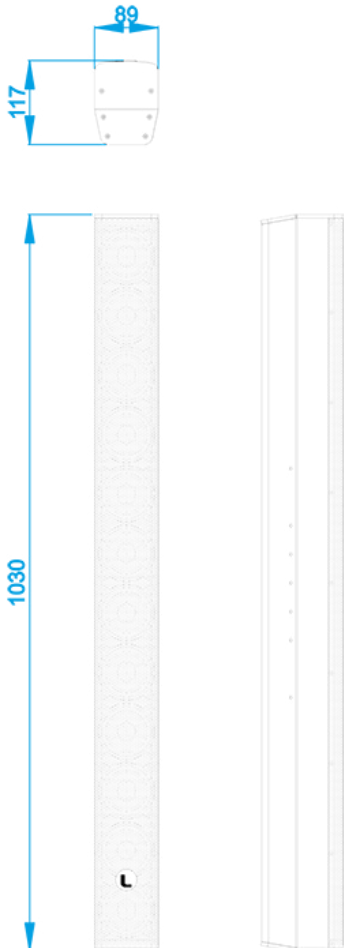

- Ionic-100 column back panel

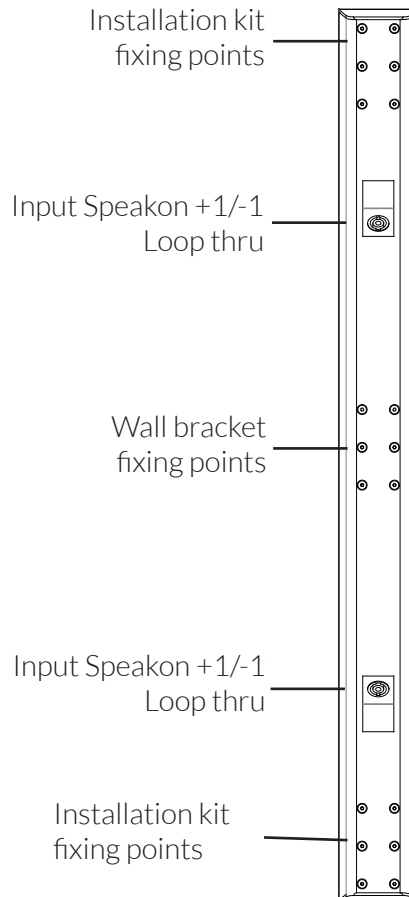

• Ionic-18S

The Ionic-18S is a powered subwoofer enclosure. It uses 1 x 18" (3" voice coil) neodymium transducers offering an ultra compact subwoofer enclosure with 132dB SPL. The power module (Class D with switching power supply) includes a Digital Signal Processor which offers different presets to cover a wide range of sound applications complementing the column speakers.

• Technical Data:

Components:	
• LF:	1 x 18" speaker with 3" voice coil
Frequency range:	38 Hz – 250 Hz (-10dB)
Frequency response:	42 Hz – 250 Hz (± 3dB)
Max SPL / Peak:	132 dB
Coverage angle:	Omnidirectional
Power amplifier:	2400W Class D with switching power supply & PFC LF amplifier: 1 x 1400W
Speaker output amplifier:	2 x 600 W @ 4 Ω
Processing:	96 KHz / 64 bit double-precision, DSP with FIR filter linear phase
Control:	User control interface with 2.8" IPS screen
Control connections:	Ethernet (OCS) / USB (DSP programming)
Input:	Analog / AES3 optional
AC Power:	85 – 270V. 50/60 Hz with PFC
AC Connectors:	16A Neutrik powerCon TRUE1 TOP with looping output
Finish:	Polyurea coating, high grade resistant paint
Material:	15 mm Premium birch plywood
Dimensions:	513 x 505 x 704 mm (H x W x D)
Weight:	37 kg (81.5 lbs)

• Ionic-18S measurements

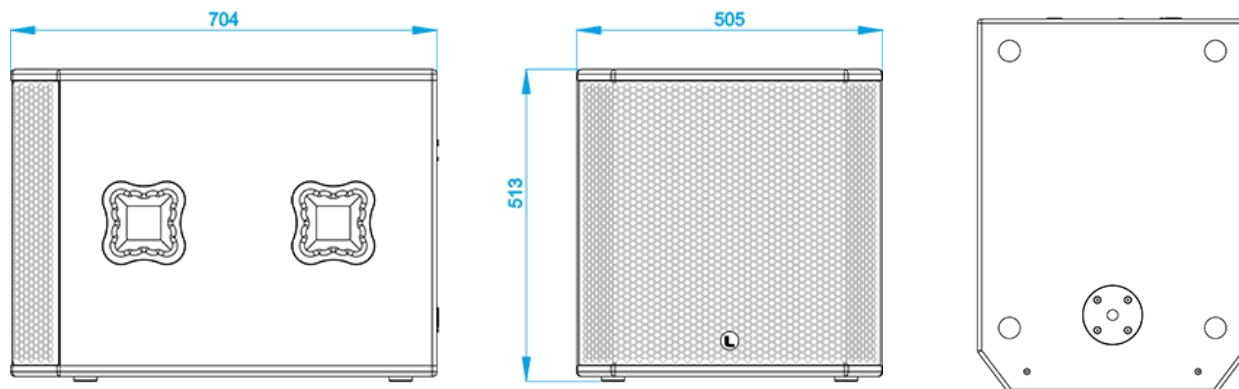

BACK PANEL

The Ionic-100 columns are powered from the active subwoofers Ionic-18S. In the following drawing you can see the back panel of the Ionic-18S, which includes the power amplifications and the digital signal control board.

From the sub unit back panel you can also select various preset configurations using the IPS display with multifunctional joystick control. You can see how to configure the cabinet DSP options in the following pages.

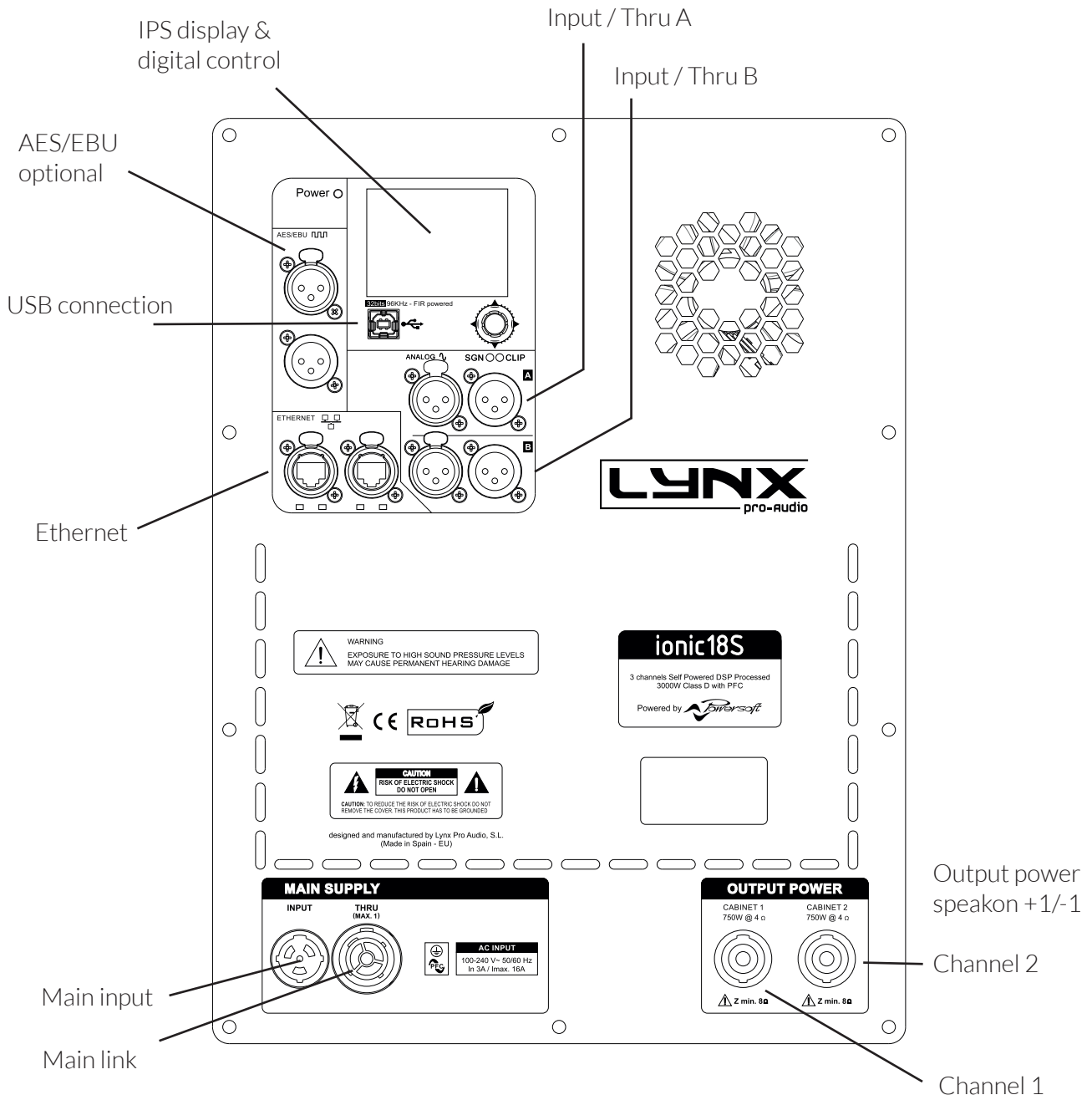

* Available when the user has requested the cabinets to be supplied with the Ethernet Module kit.

CONNECTORS AND CONNECTIONS



CAUTION: Do not connect or disconnect the AC Power connectors under load.

SOCKET POWERCON TRUE1

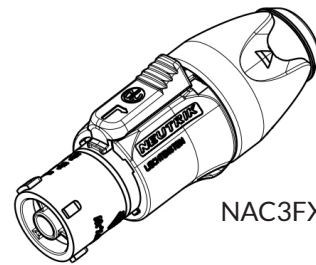
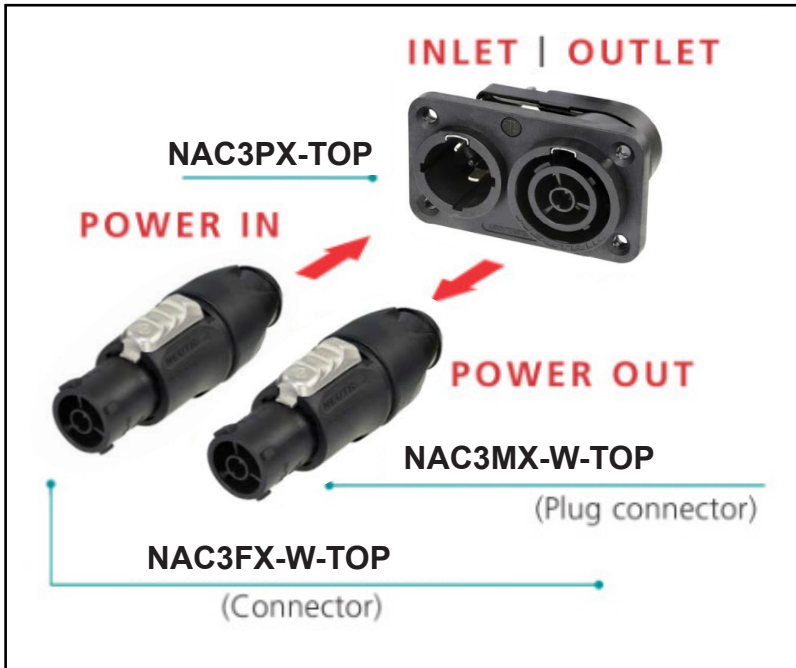
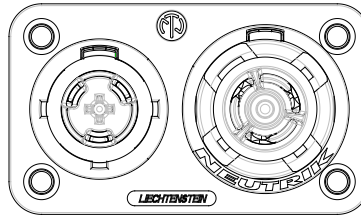

NAC3FX-W-TOP

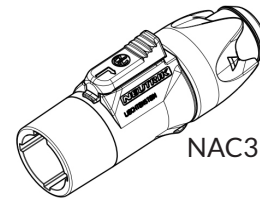

NAC3MX-W-TOP

XLR SOCKET CONNECTORS

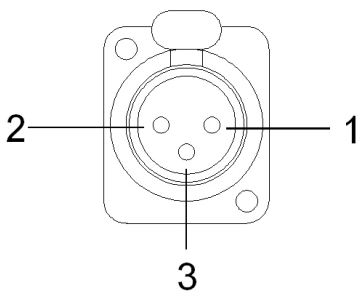

INPUTS
1.- EARTH
2.- LIVE (+)
3.- LIVE (-)

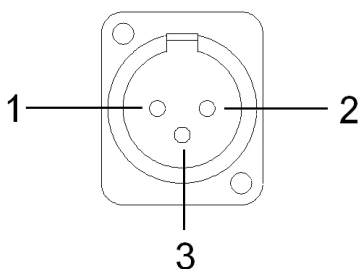

OUTPUTS
1.- EARTH
2.- LIVE (+)
3.- LIVE (-)

XLR AERIAL CONNECTORS

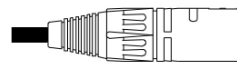

Connect to input

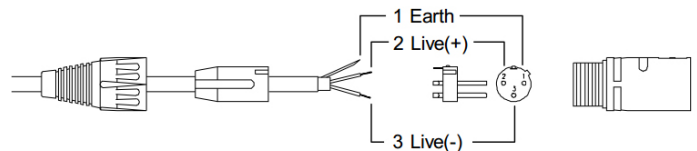

Connect to output

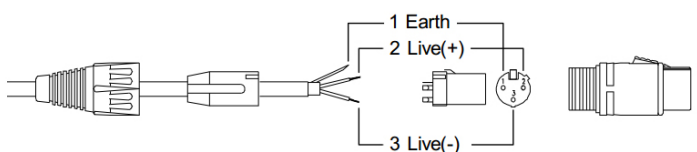

CONNECTORS AND CONNECTIONS

• ACOUSTIC CENTRE

When mounting an Ionic column is essential to understand that the height of the unit above the floor level is extremely critical. The correct operational height is the height of the ionic's "acoustic centre". The acoustic centre of the Ionic-100 is located between the six speakers of the top.

When two Ionic-100 columns have to be used to form one column then the upper column must be placed upside down, so its acoustic centre is in touch with the acoustic centre of the above cabinet. Note that the Lynx round logo indicates which way is up, so you can see when a column is upside down, when you see that the round logo of the cabinet is at the top of the column, and the L is inverted.

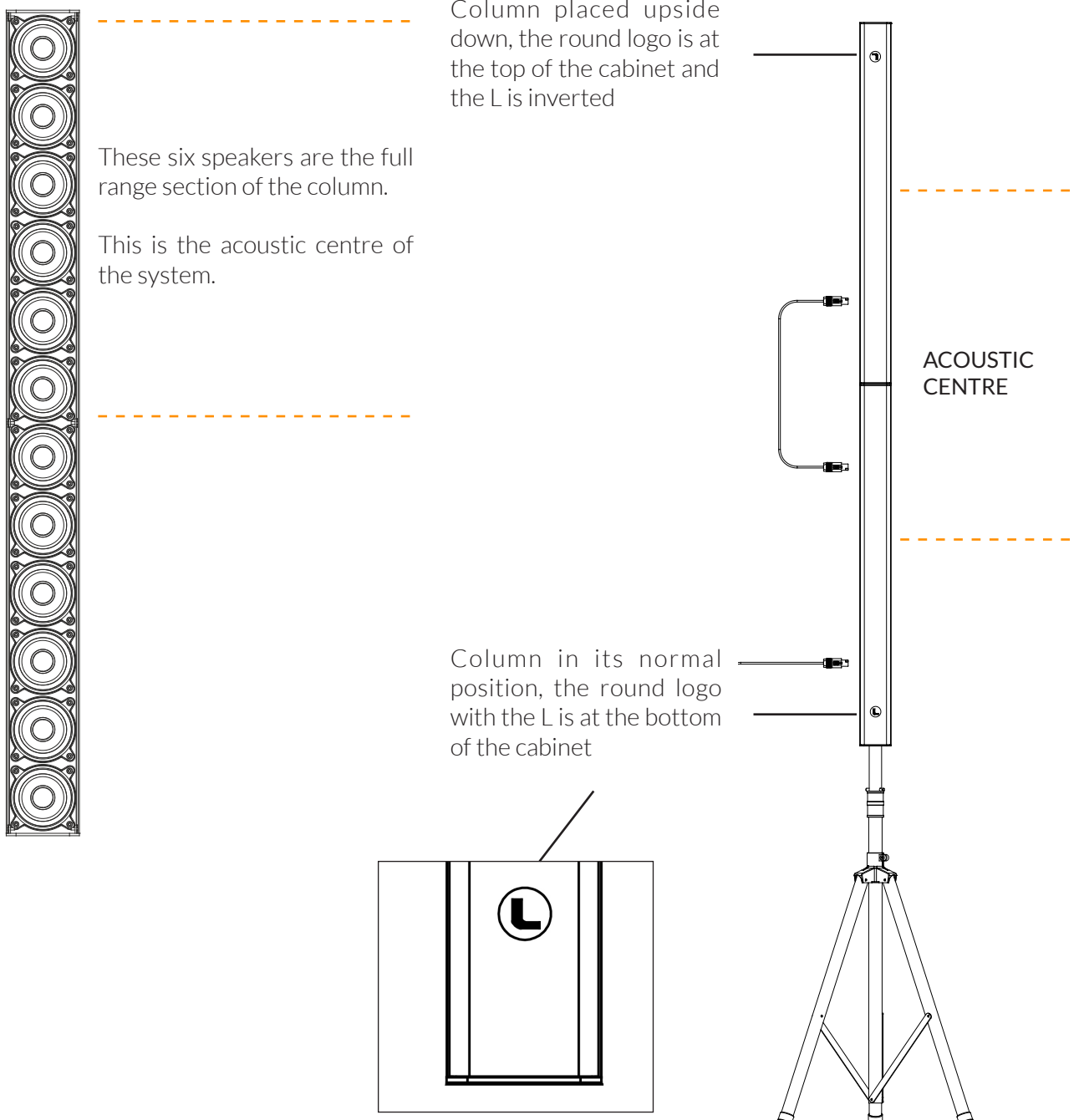

CONNECTORS AND CONNECTIONS

- CONNECTION EXAMPLE (mono channel): Two Ionic-100 + one Ionic-18S PRESET 1

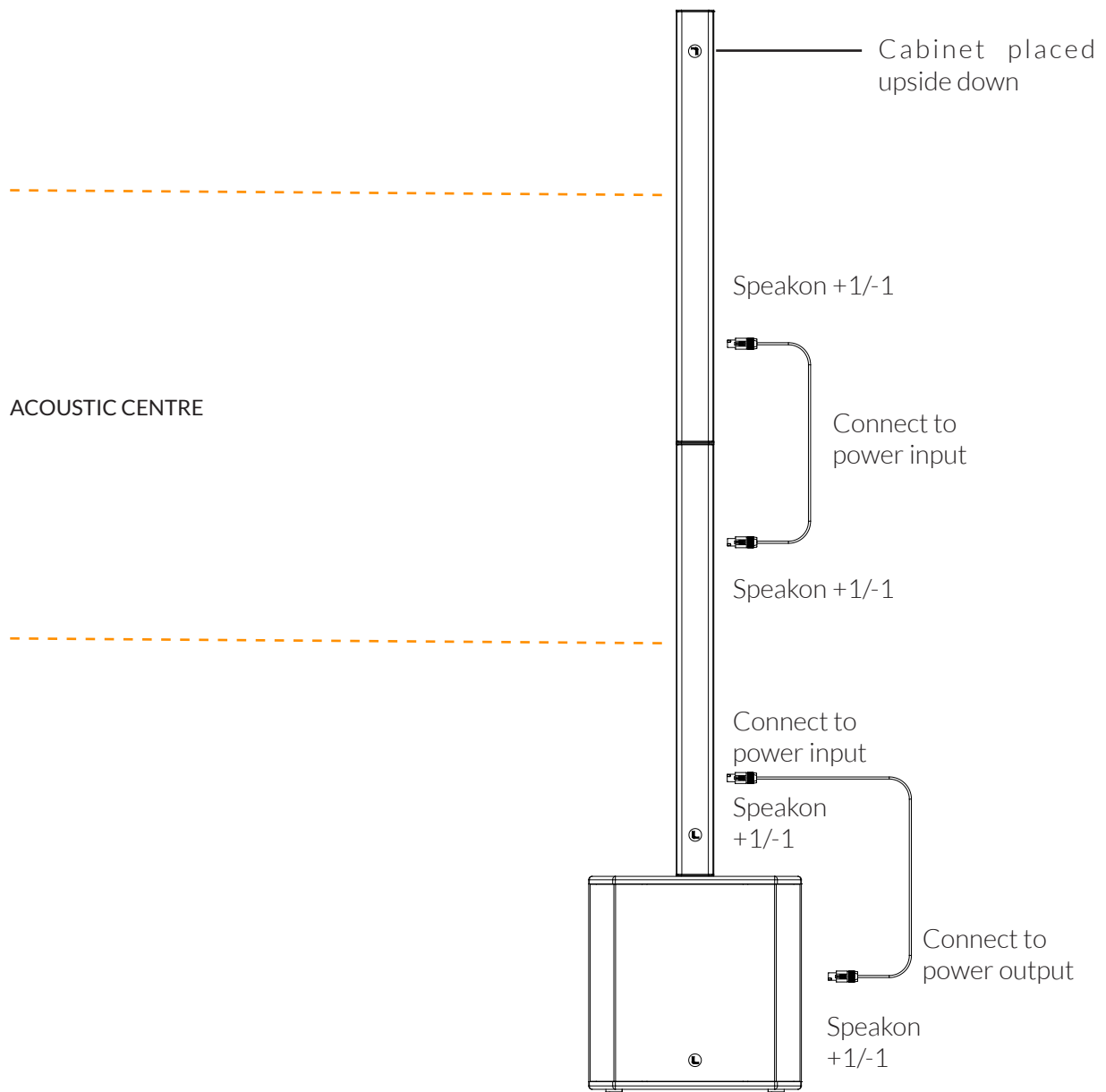

CONNECTORS AND CONNECTIONS

- CONNECTION EXAMPLE (L + R + SUB): 2 Ionic-100 + 1 Ionic-18S PRESET 2

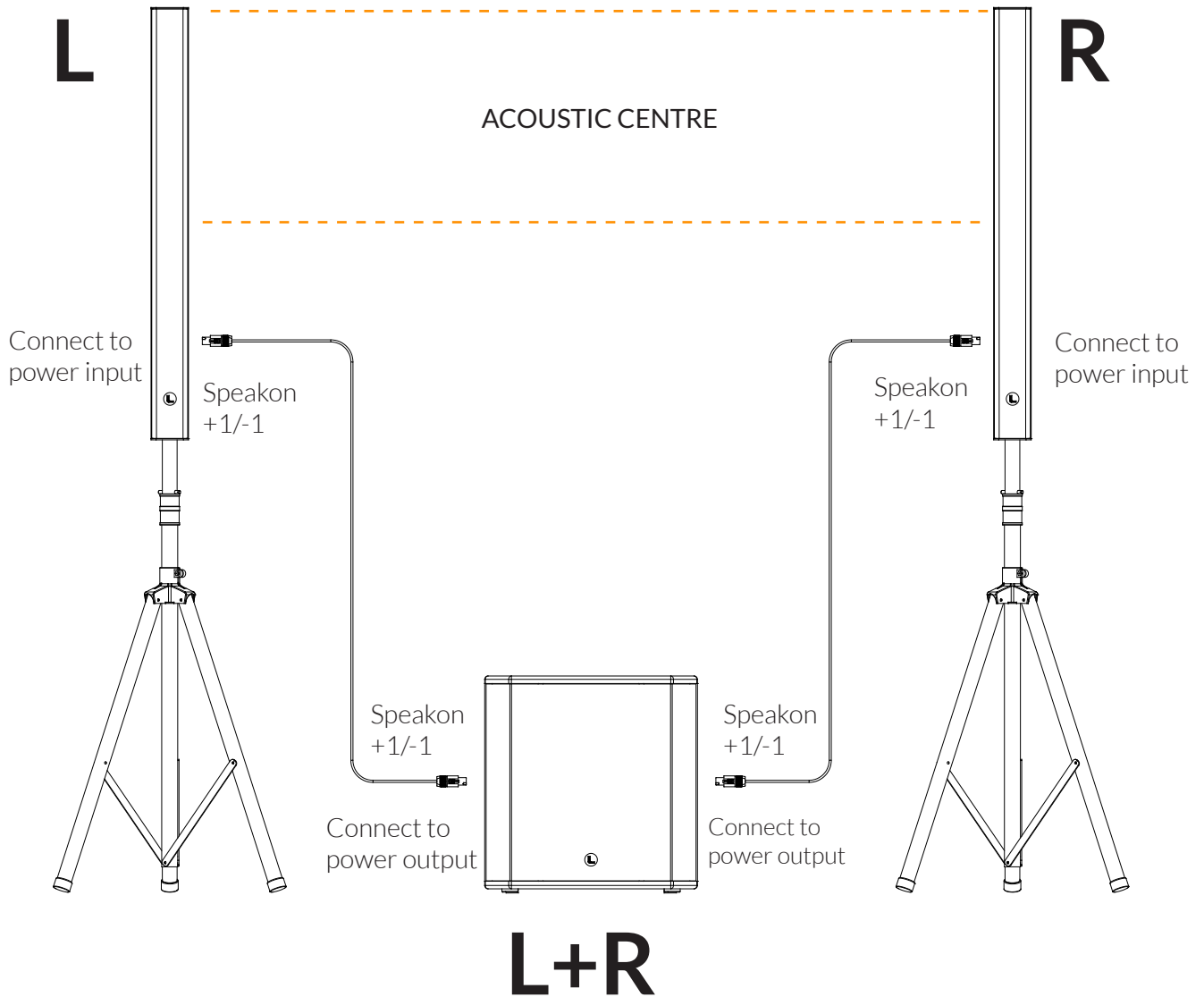

CONNECTORS AND CONNECTIONS

- CONNECTION EXAMPLE (L + R + SUB): 4 Ionic-100 + 1 Ionic-18S PRESET 3

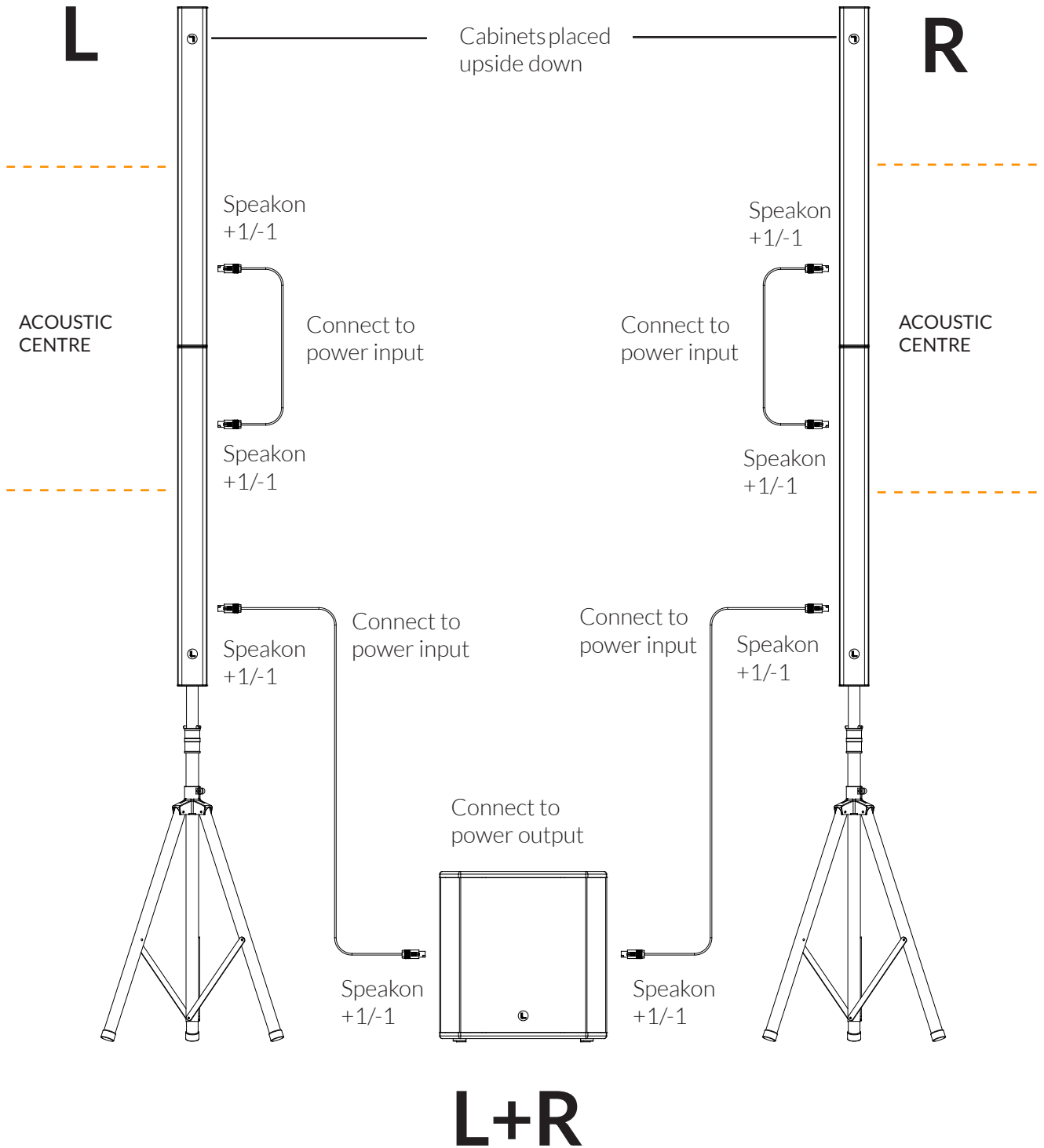

FIR FILTERS

Finite Impulse Response (FIR) filters are used in the signal processing of the cabinets. FIR is a type of digital filter with linear phase characteristics. This frees system designers from the constraints of phase anomalies associated with analogue filters or their digital versions (IIR, Infinite Impulse Response). When properly used, FIR filtering can audibly improve a system's impulse response and reduce crossover interference.

CONFIGURING THE CABINET DSP OPTIONS

On the back panel of the cabinet you will find the digital control area. From the compact joystick located below the screen you are able to configure the Basic adjustment functions of the internal DSP. Just move the joystick to select the icons on the left of the screen. You can enter into the following functions:



Please note that you must apply the desired configuration in each one cabinet and requires electrical power to work.

If changes are not made the display will automatically dim to avoid unnecessary light in situations where light is not wanted. To re-activate the light simply press the joystick.

CONFIGURATION PANEL

On the main screen you can see the cabinet's input and output.

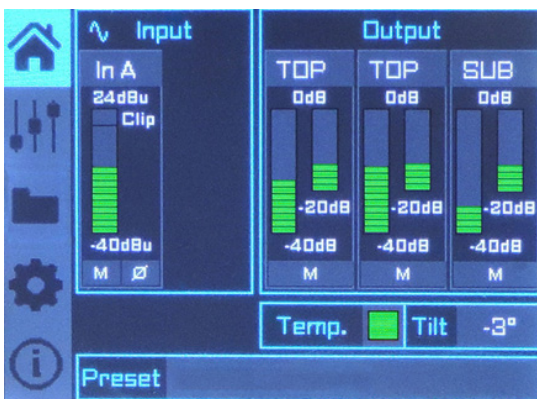

- **Input:**

You can see a vumeter with the input level and a clip signal.

- **Output:**

You have a vumeter with the output level (0 dBu is the amp's maximum level) You can check the compressor and control the dynamic activity.

On the second screen you can modify some parameters.



- **Gain**

- **Mute**

- **Polarity**

- **Delay**

- **High Pass Filter:** You can setup a High Pass filter selecting type, frequency and order.

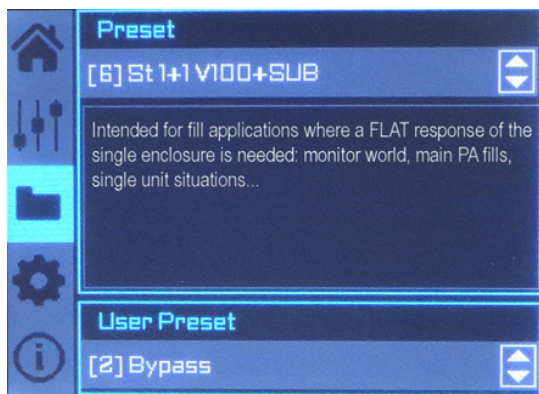

The folder screen shows you the name of the preset and its description.

Using the joystick you can change the preset.

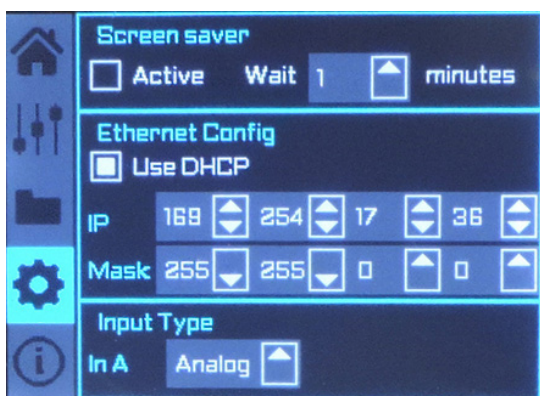

This screen is to configurate Ethernet. You can choose automatic or manual

You can also configure the screen saver.

And here you have the input selection. You can choose between analog or AES3 for channel 1 or channel 2.

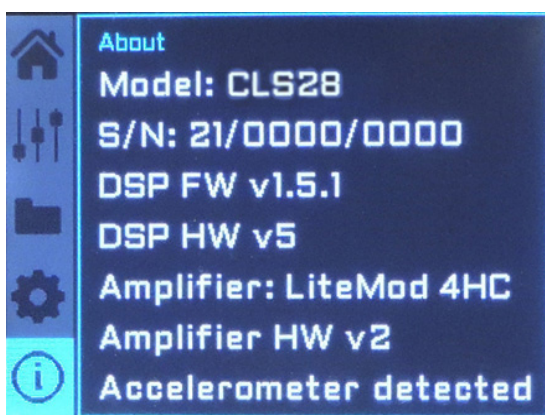

The last screen shows you some general information regarding the cabinet's components.

Here you can see the cabinet model, its serial number, DSP firmware and hardware versions, amp module model with hardware version, as well as the accelerometer status.

ONLINE CONTROL SYSTEM

- Who is it for?

Users of Self powered DSP incorporated Lynx Pro Audio Cabinets where the user has requested the cabinets be supplied with the Ethernet Module kit.

- What is it for?

Obtain detailed information of cabinet behaviour and monitor the cabinet/s in real time. You can change the preset, gain, mute, polarity and phase. You can also activate the air absorption compensation and select the «SOLO» mode.

- How does it work?

Via Ethernet (cable or wireless). Once installed, the O.C.S. software automatically detects all the cabinets connected to the network and displays them in the O.C.S. window on the users PC.

- What does it show?

As well as displaying the cabinet model and IP address the O.C.S will be monitoring in real time and the user will be able to view RMS levels, Input clip, power module temperature, compression levels, air absorption compensation and cabinet angulation.

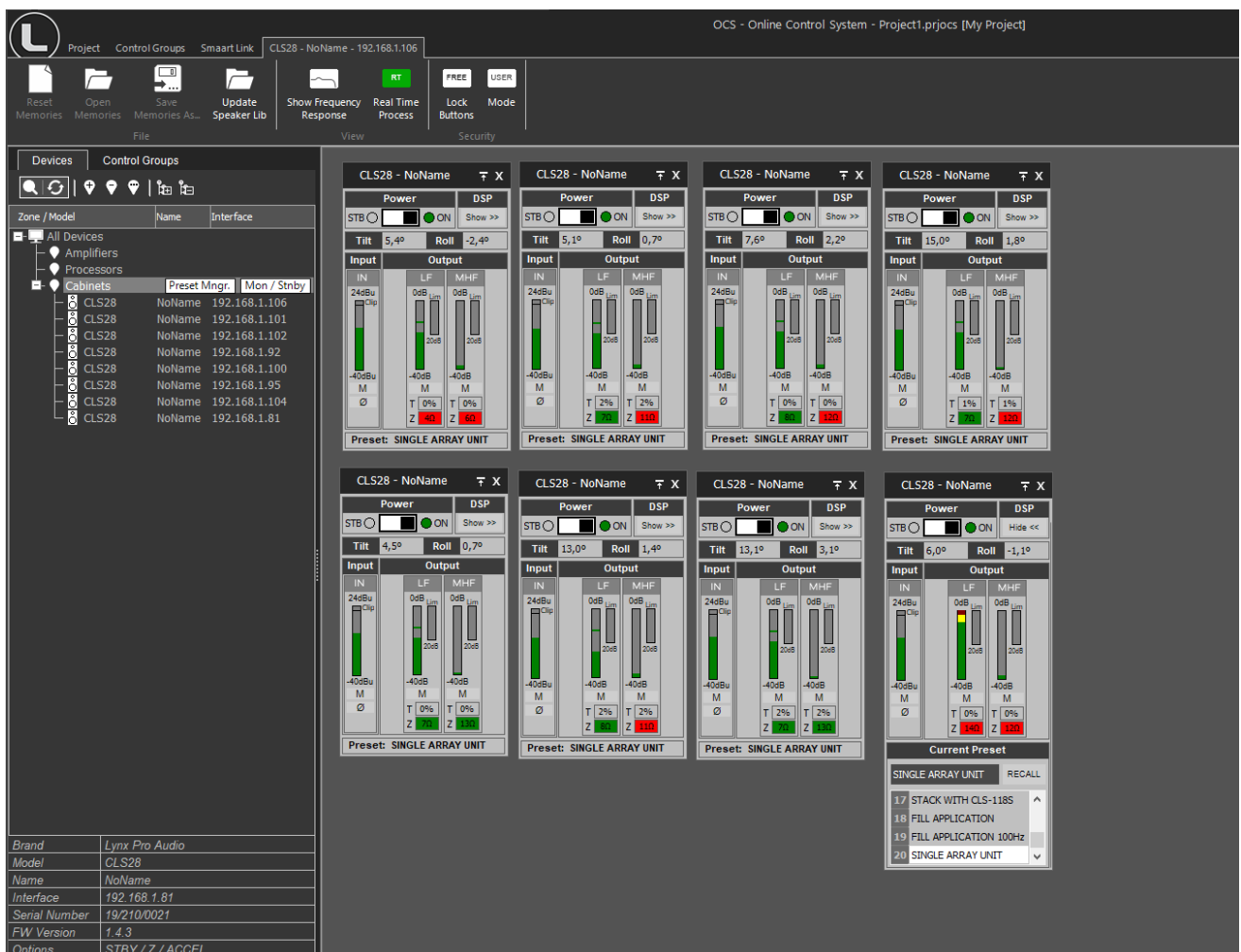

RAINBOW 3D Acoustic Prediction Software

Lynx Pro Audio's R&D department is working on Rainbow 3D, a new acoustic simulation software with dynamic 3D features. With a sophisticated design, Rainbow 3D stands out for its speed, being able to provide a simulation in just a few seconds. It also provides algorithms for beam steering and optimizing the listening area.

- **Designed from scratch by professionals**

Rainbow 3D has been programmed from scratch by Lynx Pro Audio engineers, using new programming procedures that achieve an effective simulation with really low calculation time.

- **Multiple listening zones**

The program can simulate all Lynx Pro Audio's acoustic enclosures located in a 3D space, including the classic side, top and front views. It can also define multiple listening zones and allows offset positioning and symmetry. Blueprint images, textures and PNG format pictures can be imported.

- **Unlimited sound sources**

Allows the acoustic simulation for an unlimited number of sound sources and audio systems. You can place as many systems (subwoofers, line arrays, columns and individual boxes) as you desire. Also, the line arrays can be placed in stack or flown configuration.

- **Beam steering**

Rainbow 3D has the ability to add DSP processing to the simulation and uses algorithms to control the directivity (beam steering) in columns, without the need to tilt them physically, being able to divide the column into several beams that point to different zones.

- **Accurate optimization thanks to FIR filters**

Optimized algorithms are used in the listening area to improve the sound coverage and the frequency response. This feature can be executed in a matter of seconds. Additionally, the export of FIR coefficients can be performed with the optimization for later loading in the DSP via Ethernet or a USB device. In the near future direct communication with Lynx Pro Audio and OCS will be available.

- **Multiple measures and tools**

Likewise, the R&D department is developing multiple measurement and analysis tools for the calculated data. For example, the sound pressure curves (SPL) in the listening areas and the capture of virtual measurements that show the frequency response in the points of location indicated and added. Among other tools you will find autoplay and a wizard to set up different subwoofer arrangements.

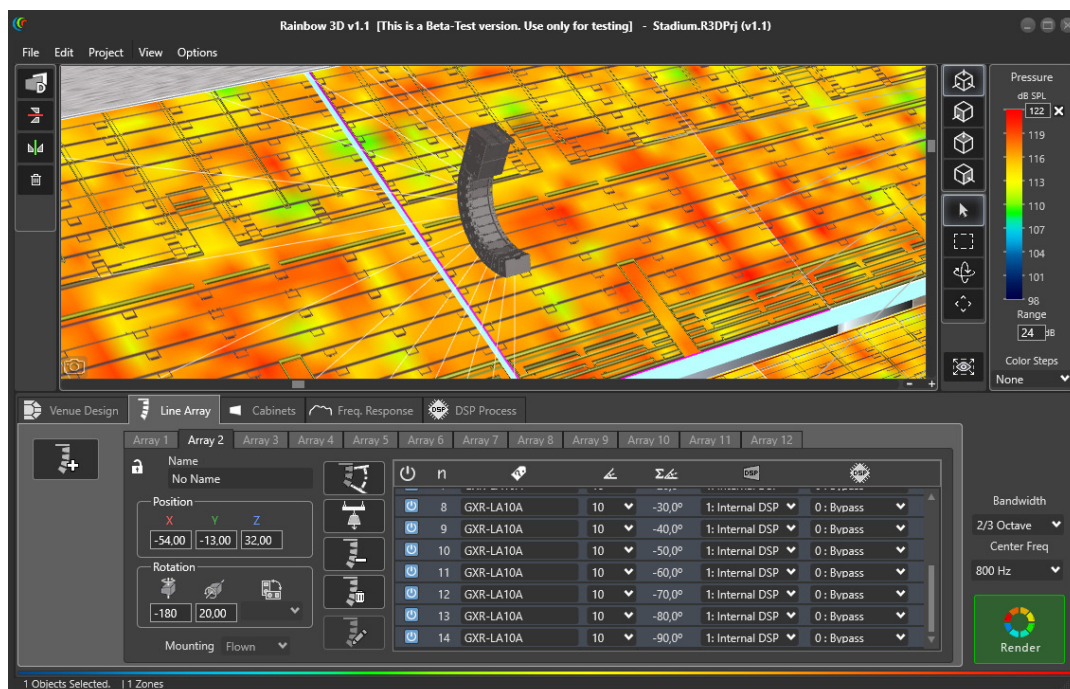

WALL INSTALATION

This is the way to install Ionic-100 column speakers into walls. These column speakers are ideal for clubs, theatres, houses of worship, public buildings and commercial complex applications.

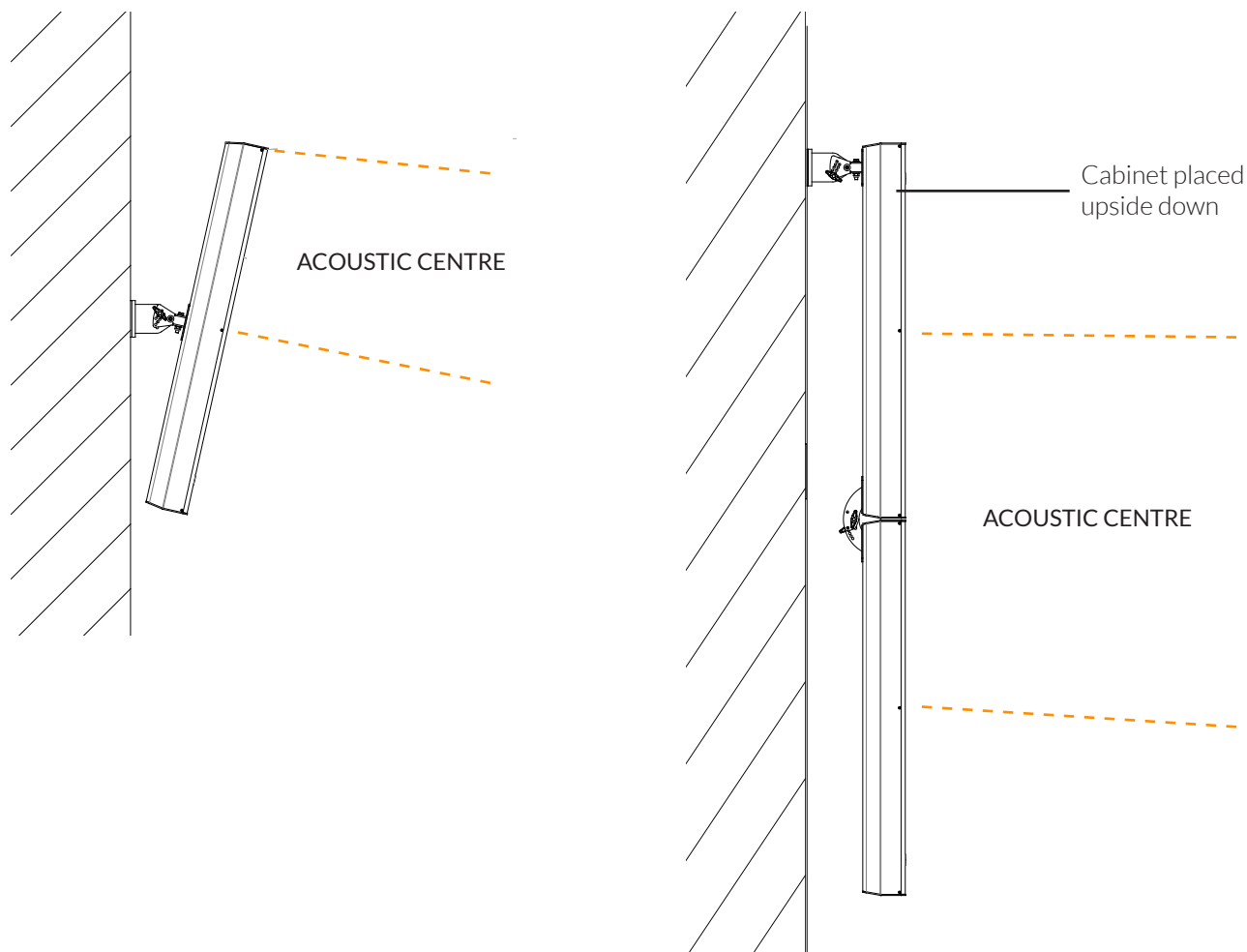

HARDWARE AND ACCESSORIES

The Ionic cabinets offer a variety of practical accessories to help use the system in a number of applications.

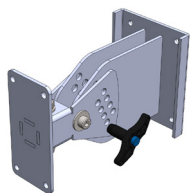

WB-1
Wall bracket

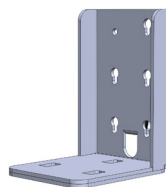

SV-12S
Sub adaptor for
satellite

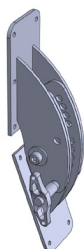

SV-21
Cabinet connection

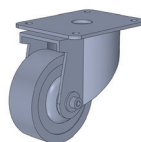

GR-18WKIT
Wheel kit for sub unit



DECLARATION OF CONFORMITY

Lynx Pro Audio S.L.
Calle 1 - Pol. Ind. Picassent
46220 Picassent (Valencia)
SPAIN - EU
Tel.: (+34) 961 10 96 01
www.lynxproaudio.com

Lynx Pro Audio S.L. declares that ionic series are in conformity with the following EC directives:

Low Voltage Directive	2006/95/EC
Electromagnetic Compatibility EMC	2004/108/EC
RoHS Directive	2002/95/EC

In accordance with Harmonized European Norms:

EN 60065:2002	Audio, video and similar electronic apparatus. Safety requirements
EN 55103-1:1996	Electromagnetic compatibility. Product family standard for audio, video, audiovisual and entertainment lighting control apparatus for professional use. Part 1: Emission.
EN 55103-2:1996	Electromagnetic compatibility. Product family standard for audio, video, audiovisual and entertainment lighting control apparatus for professional use. Part 2: Immunity.
Ionic models:	Ionic-50 / Ionic-100 / Ionic-18S / Ionic-12S / Ionic-5CX / Ionic-5CXv



LYNX PRO AUDIO GUARANTEE

Lynx products are guaranteed against every kind of manufacturing fault 2 year after the date of sale. When products are under guarantee, the repairing and the free supplying of the device parts in order to correct any kind of defect are guaranteed by Lynx Pro Audio S.L. In the case that the product could not be returned to the factory for checking and repairing, Lynx Pro Audio S.L. would supply all the necessary parts.

Lynx Pro Audio S.L. is not responsible for any damage or defect caused during the transport or caused by an undue or improper handling by a non-authorized person during the life of this guarantee.

All our products undergo rigorous tests and quality controls. We guarantee the characteristics described here within and their quality against any fabrication defect.

The user loses all warranty rights if he incorporates or carries out any modification to the product, if he uses it outside of the stated safe working loads or does not secure the system properly using all the pins in their corresponding holes.

For any question regarding the product, the user must quote the model and serial number.

WEEE Declaration: Electrical and electronic equipment must be disposed of separately from normal waste at the end of its operational lifetime. Please dispose of this product according to the respective national regulations or contractual agreements. If there are any further questions concerning the disposal of this product please contact Lynx Pro Audio S.L.