

i7-XR USER GUIDE

roon
TESTED

BUILDING A BETTER MUSIC EXPERIENCE

CONTENTS

IMPORTANT! READ BEFORE OPERATING THIS EQUIPMENT! ...1	REMOTE CONTROL OPERATION17
Power supply2	Remote control introduction17
Servicing2	Remote control backlight17
Product service centres2	Fitting batteries to the remote control17
FCC Notice3	Sending commands to Cyrus components17
WELCOME TO THE WORLD OF CYRUS4	Switching on Cyrus source components17
Preparations for Installation4	Cyrus amplifier commands18
INSTALLATION5	Cyrus CD player commands19
Key to the rear panel drawing5	Cyrus audio streamer commands20
Important – read before making any connections6	Cyrus Phono Signature commands21
Connecting analogue audio sources6	SETUP MENUS22
Connecting a turntable6	Setup options22
Connecting digital audio sources6	Navigating the menu from the front panel22
Connecting a USB audio device6	Navigating the menu from the remote control22
Connecting loudspeakers7	Menu maps23
Bi-wiring8	FIRMWARE UPDATES25
Bi-amping9	REMOTE CONTROL LEARNING26
Bi-amping cautions9	Preparation for learning26
Using the fixed output of your amplifier10	Learning commands26
Connecting a tape recorder for recording10	Checking programmed commands27
Connecting a second amplifier10	Problems with learning27
Connecting headphones10	Sending TV or SAT commands27
Connecting a Cyrus surround sound decoder10	TROUBLESHOOTING GUIDE28
Connecting a surround sound decoder (other brand)10	Error indication28
MC-BUS system11	SPECIFICATIONS29
Connecting to the AC mains supply11	Power Supply29
OPERATION12	Power Consumption29
Key to the front panel drawing12	Enclosure29
Touch pad controls12	Analogue audio performance29
Power12	Digital audio performance at pre-out29
Mains power12	ACKNOWLEDGEMENTS29
Standby12	WARRANTY29
Auto-standby12	WEEE29
Selecting an input12	
Inputs set with ‘Cyrus AV’ or ‘AV Direct’ response12	
Playing USB audio from a computer13	
Playing DSD audio from a computer13	
Volume level and channel balance13	
Volume13	
Headphone volume13	
Safe volume levels after standby13	
Balance13	
Mute14	
Headphones14	
Filter15	
Tape playback and recording16	
Playback16	
Recording16	
Playing through a second amplifier16	

IMPORTANT! Read before operating this equipment!

CAUTION: The exclamation mark is to draw your attention to important instructions and safety procedures in this manual.



ATTENTION: The lightning flash warns you of the risk of electrical shock presented by components inside this product. Unauthorised personnel must not open this unit.



WARNING: To reduce the risk of electrical shock do not remove any unit covers or panels. There are no user serviceable parts in this product.

WARNING: To reduce the risk of electric shock, do not expose this equipment to rain or moisture.

HEED WARNINGS: All warnings on the product and in the operating instructions should be adhered to.

READ ALL THE INSTRUCTIONS: All the safety and operating instructions should be read before the product is operated.

RETAIN INSTRUCTIONS: The safety and operating instructions should be retained for future reference.

FOLLOW INSTRUCTIONS: All operating and use instructions should be followed.

CLEANING: Unplug this product from the mains before cleaning. Do not use liquid or aerosol cleaners. Use a damp cloth for cleaning.

WATER AND MOISTURE: Do not use this product near water - for example, near a bath tub, wash bowl, kitchen sink, or laundry tub, in a wet basement; or near a swimming pool and the like. The product must not be exposed to dripping or splashing and no objects filled with liquids, such as vases, shall be placed on the product.

HEAT: The product should be situated away from heat sources such as radiators, stoves, or any other products (including amplifiers) that produce heat.

VENTILATION: Slots and openings in the cabinet are provided for ventilation, to ensure reliable operation of the product and to protect it from overheating and these openings must not be blocked or covered. The openings should never be blocked by placing the product on a bed, sofa, rug or similar surface. This product should not be placed in a built-in installation such as a bookcase or rack unless proper ventilation is provided or the manufacturer's instructions have been adhered to.

OBJECT OR LIQUID ENTRY: Never push objects of any kind into this product through openings as they may touch dangerous voltage points or short-out parts that could result in a fire or electric shock.

ACCESSORIES: Do not place this product on an unstable cart, stand, tripod, bracket, or table. The product may fall, causing serious injury to a child or adult, and serious damage to the product. Use only with a cart, stand, tripod, bracket or table recommended by the manufacturer, or sold with the product. Any mounting of the product should follow the manufacturer's instructions, and should use a mounting accessory recommended by the manufacturer.

ATTACHMENTS: Do not use attachments not recommended by the product manufacturer as they may cause hazards.

MOVING THE PRODUCT: A product and cart combination should be moved with care. Sudden stops, excessive force, and uneven surfaces may cause the product and cart to overturn.



POWER SOURCES: This product should be operated only from the type of power source indicated on the marking label. If you are not sure of the type of power supply to your home, consult your product dealer or local power company. For products intended to operate from battery power, or other sources, refer to the operating instructions.

OVERLOADING: Never overload wall outlets, extension cords, or integral convenience receptacles. This can result in an increased risk of fire or electric shock.

POWER CORD PROTECTION: Power supply cords should be routed so that they are not likely to be walked on or pinched by items placed upon or against them, paying particular attention to cords at plugs, convenience receptacles, and the point where they exit from the product.

NAKED FLAMES: No naked flame sources, such as candles, must be placed on this product.

LIGHTNING: For added protection for this product during a lightning storm, or when it is left unattended or unused for long periods of time, unplug it from the wall outlet and disconnect the antenna or cable system. This will prevent damage to the product due to lightning and power-line surges.

BATTERIES: Warning: Batteries shall not be exposed to excessive heat such as sunshine, fire or the like.

CAUTION! POLARISED CONNECTOR (CANADA and USA):

To prevent electrical shock, match wide blade of plug to wide slot, fully insert. Do not alter or remove this plug if it does not fit your mains power socket. Have a suitable socket installed by a competent electrician.

ACCESS TO THE MAINS PLUG: The means to disconnect this product from the mains supply is the mains plug. Ensure that the mains plug is accessible at all times.

Power supply

Connect the moulded IEC connector of the supplied AC cord into the power inlet on the rear of the unit.

The mains supply requirement of your amplifier is marked on a label on the rear panel. Before connecting, check that this voltage is the same as your mains supply.

220-230V Products: Voltage Range 220V-240V

115V Products: Voltage Range 110V-120V

If you move to an area with a different mains voltage, contact your local Cyrus distributor to have your product converted.

There are no user replaceable fuses in this unit.

Servicing

Do not attempt to service this product yourself as opening or removing covers may expose you to dangerous voltage or other hazards. Refer all servicing to qualified service personnel.

CONDITIONS REQUIRING SERVICE: Unplug this product from the wall outlet and refer servicing to qualified service personnel when:

- When the power supply cord or plug is damaged.
- If liquid has been spilled, or objects have fallen into the product.
- If the product has been exposed to rain or water.
- If the product has been dropped or damaged in any way.
- If the product does not operate normally by following the operating instructions. (Adjust only those controls that are covered by the operating instructions. Improper adjustment of other controls may result in damage requiring extensive work by a qualified technician to restore the product to its normal operation).
- When the product exhibits a distinct change in performance.

REPLACEMENT PARTS: When replacement parts are required, be sure the service technician has used replacements specified by the manufacturer or have the same characteristics as the original part. Unauthorised substitutions may result in fire, electric shock, or other hazards.

SAFETY CHECK: Upon completion of any service or repairs to this product, ask the service technician to perform safety checks to determine that the product is in proper operating condition.

Product service centres

For product service or technical advice, contact only authorised Cyrus service centres. Contact details for Cyrus distributors may be found on the Cyrus website at www.cyrusaudio.com.

FCC Notice*

NOTE: This equipment has been tested and found to comply with the limits for a Class B digital device, pursuant to Part 15 of the FCC rules. These limits are designed to provide reasonable protection against harmful interference in a residential installation. This equipment generates, uses and can radiate radio frequency energy and, if not installed and used in accordance with the instructions, may cause harmful interference to radio communications. However, there is no guarantee that interference will not occur in a particular installation. If this equipment does cause harmful interference to radio or television reception, which can be determined by turning the equipment off and on, the user is encouraged to try and correct the interference by one or more of the following measures:

- Reorient or relocate the receiving antenna.
- Increase the separation between the equipment and receiver.
- Connect the equipment into an outlet on a circuit different from that to which the receiver is connected.
- Consult the dealer or an experienced radio/TV technician for help.

Any changes or modifications not expressly approved by the manufacturer could void the user's authority to operate the equipment.

*115V products

Welcome to the world of Cyrus

Congratulations on your choice of Cyrus Hi-fi products. Our state-of-the-art design technology and outstanding quality of manufacture has won countless awards around the world. We are confident that you will derive great pleasure from owning a product from one of the most recognised and respected manufacturers of hi-fi equipment.

Now is a good time to register your new Cyrus product.

To register, click [here](#) or visit - www.cyrusaudio.com/support/warranties.

Please read these instructions carefully before commencing installation. They provide full guidance to help you install your amplifier safely and correctly.

Preparations for Installation

Before installing your Cyrus amplifier check that the following items are included in the accessory box.

- Power Cable
- Remote Handset with Batteries
- 4 Loudspeaker Plugs
- Quick-Start guide

After removing these items, please retain the packaging.

Install the amplifier in a well ventilated location away from sources of high temperature, dust or humidity. Never stand the amplifier under another unit or on any surface likely to obstruct its cooling or ventilation.

Installation

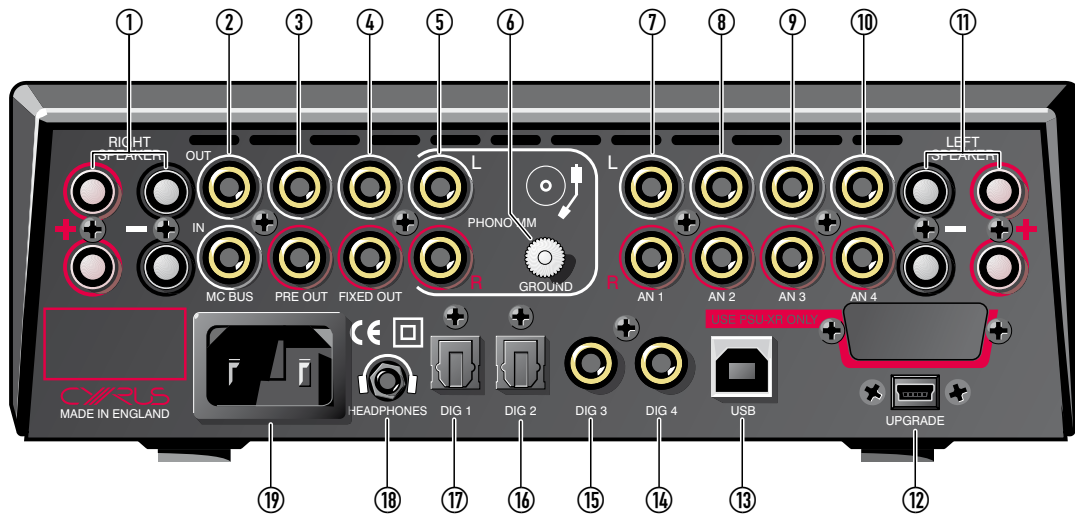

Key to the rear panel drawing

- | | | |
|-----------------------------|--------------------------|--------------------------|
| 1. Right speaker output | 8. AN2 analogue input 2 | 15. DIG3 digital input 3 |
| 2. MC-BUS system connection | 9. AN3 analogue input 3 | 16. DIG2 digital input 2 |
| 3. Pre-amplifier output | 10. AN4 analogue input 4 | 17. DIG1 digital input 1 |
| 4. Fixed output | 11. Left speaker output | 18. Headphone socket |
| 5. Phono/MM input | 12. Upgrade port | 19. Power inlet |
| 6. Phono ground terminal | 13. USB input | |
| 7. AN1 analogue input 1 | 14. DIG4 digital input 4 | |

Important – read before making any connections



To avoid possible damage to your audio system, it is essential to disconnect all system components from the mains supply before connecting or disconnecting audio interconnects.

Connecting analogue audio sources

- Connect a stereo audio interconnect cable between each analogue source component and one of the analogue input sockets 'AN1 - AN4'.

Ensure left and right channels are correctly connected.

Make a note of the input number used for each source as the inputs can be re-named at the set-up stage.

The analogue inputs are compatible with the connection of stereo analogue audio sources. These include-

Analogue output from CD/Blu-ray Players

Analogue output from DAB or FM radio tuners

Analogue output from a TV

Analogue tape recorders

Surround decoders

Connecting a turntable

The PHONO/MM input is compatible with turntables fitted with moving-magnet cartridges (for moving coil cartridges an external phono stage will be required, connected to an analogue input). The turntable will have a cable with two plugs, and often a thin ground wire with a tag.

- Connect the plugs to the 'PHONO/MM' sockets on the back panel. Connect the white plug to the left socket and the red plug to the right socket.
- Unscrew the 'GROUND' terminal then fasten the ground wire (where fitted) under the terminal.

Connecting digital audio sources

- Using a suitable Toslink optical or digital phono interconnect, connect each digital audio source to one of the inputs 'DIG1 - DIG4'.

Make a note of the input number used for each source as the inputs can be re-named at the set-up stage.

The digital audio inputs are compatible with a number of different digital audio sources. These include-

Digital audio output from a CD player

Digital audio output from a TV

Digital audio output from a games console

Digital radio

Blu-ray players

Digital satellite receivers

Digital tape/disc recorders

NOTE: The digital audio inputs are only compatible with 2 channel PCM source material and will not reproduce multi-channel surround sound.

Connecting a USB audio device

The USB audio input may be used to connect the audio feed from a Windows PC or mac OS computer.

Windows computers will require the installation of a USB audio driver. This is available for download from the Cyrus website. mac OS computers do not require driver installation.

- Install the driver (if required).
- Connect a cable from a USB outlet of the computer to the 'USB B' input.

Connecting loudspeakers

Your speaker cables may have been supplied terminated with plugs that are compatible with Cyrus amplifiers. If not, fit the plugs supplied with the amplifier.

NOTE: Additional plugs are available from Cyrus. All BFA style plugs are also compatible.

- Connect the cables to the back panel speaker sockets.
The + and - speaker terminals of the amplifier must be connected to the corresponding + and - terminals of the speakers. Most cables have polarity indicators, usually a stripe or a rib on one conductor as shown in the examples below. The red plugs should be fitted to the cable with the polarity marking.

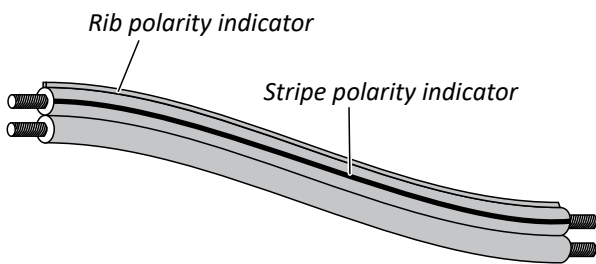

Your cables may also be marked for directionality with arrows. In this case, the arrows should always point in the direction of signal flow towards the speakers.

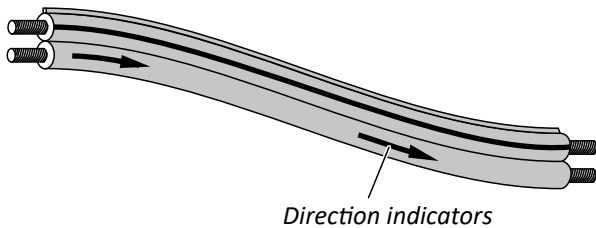

Connecting loudspeakers

Bi-wiring

Dual speaker connections are provided and either set may be used with single cables. If your speakers are bi-wirable and you have dual bi-wire cables, both can be used.

The diagram below shows bi-wired loudspeakers.

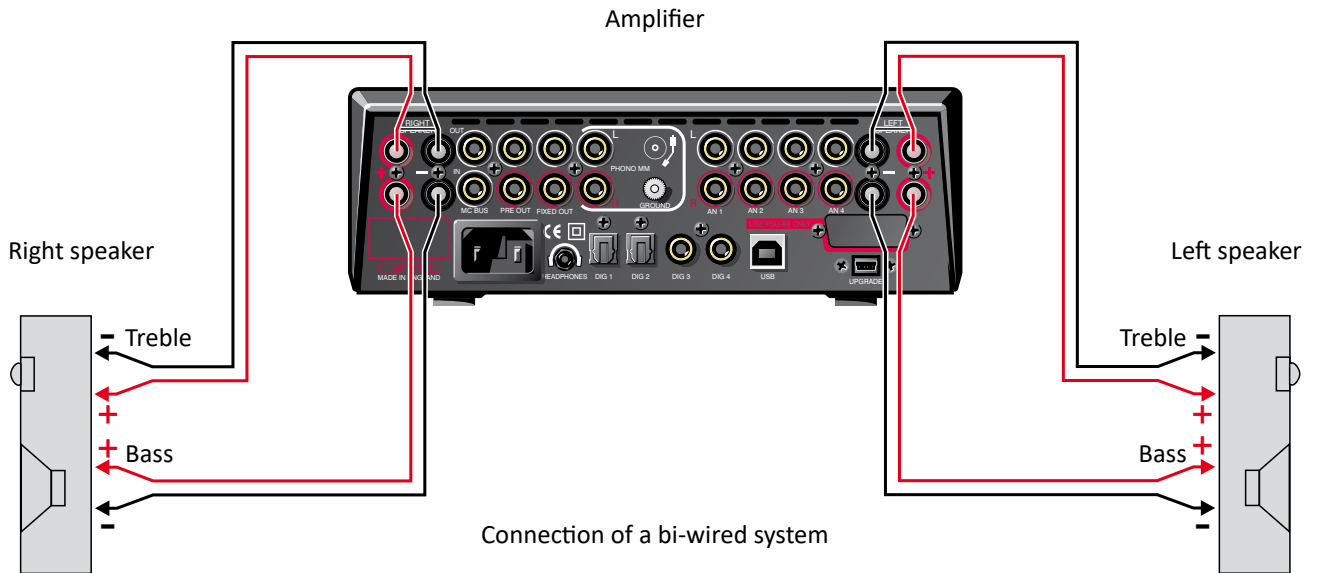

Connecting loudspeakers

Bi-amping

The pre-amplifier output may be used in conjunction with added power amplifier(s) to significantly upgrade your loudspeaker system through bi-amping.

The Cyrus range of power amplifiers is recommended for this application as they will have the correct matching gain. Both stereo and high power monobloc Cyrus power amplifiers are available to partner your amplifier.

Bi-amping cautions

NOTE: A bi-amp system can only be set up with speakers that have bi-wire connections (separate bass and treble connections).

CAUTION: Ensure that any bi-wire or bridging links are removed from the speaker terminals before connecting up a bi-amped system.

Refer to the wiring plan of a bi-amplified system below. Take care to connect each of the amplifier output channels to the correct power amplifier and loudspeaker.

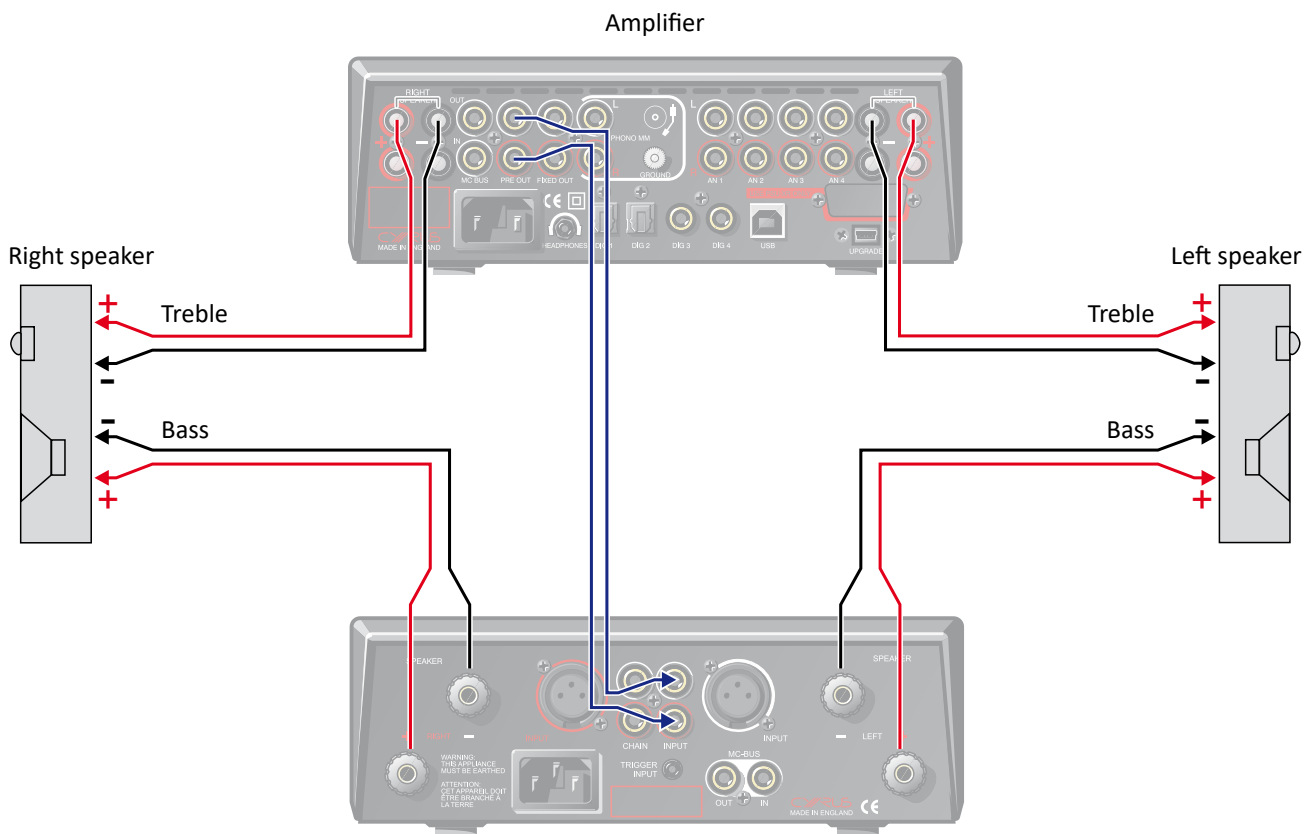

Connection of a bi-amped system

Using the fixed output of your amplifier

The fixed output will feed the sound of the source currently playing at full volume to a tape recorder, a second amplifier in another room or a pair of active speakers with built-in amplifier(s) and volume control.

Connecting a tape recorder for recording

- Using a stereo phono interconnect, connect from 'Fixed Out' to the line input or record input of a tape/disc recorder.

You can now record the source you are playing on the tape/disc recorder.

Connecting a second amplifier

NOTE: Ensure that the second amplifier includes a volume control.

- Using a stereo phono interconnect, connect 'Fixed Out' to an analogue input of a second amplifier feeding speakers in another room.

You can now play the same music in both rooms and use the volume controls on the two amplifiers to control the volume in each room separately.

Connecting headphones

- Connect headphones to the 3.5mm stereo jack socket on the back panel.

If your headphones have a larger, 6.35mm (1/4") connector an adapter cable can be used. An extension cable (not supplied) may also be used if the headphone cable is not long enough.

Headphones may be permanently connected to the amplifier and selected when required from the front panel.

Connecting a Cyrus surround sound decoder

If your system includes a Cyrus multi-channel surround sound decoder, it may be connected through your stereo amplifier to share the main, front speakers of your system.

- In this case, connect a stereo phono interconnect from the front channel outputs of the surround decoder to one of the analogue inputs of the amplifier.

For this system to function correctly both the amplifier and the Cyrus surround decoder must be included in an MC-BUS connection loop and the 'Cyrus AV' option must be set in the MC-BUS/AV menu for the input used (see the 'MC-BUS' section and 'MC-BUS/AV' in the 'Setup menu' section).

When set up in this way, the amplifier will automatically check for the presence of the decoder when the input set as 'Cyrus AV' is selected, then lock its volume setting to an appropriate level.

Connecting a surround sound decoder (other brand)

If your system includes a multi-channel surround sound decoder (but not a Cyrus model), it may be connected through your amplifier to drive the front channel speakers.

- Connect a stereo phono interconnect from the front channel outputs of the surround decoder to one of the analogue inputs of the amplifier.

For this system to function correctly, the 'AV Direct' option must be set in the MC-BUS/AV menu for the input used (see 'MC-BUS' section and 'MC-BUS/AV' in the 'Setup menu' section).

When set up in this way, the amplifier will automatically lock its volume setting to a fixed level to match the output of the surround decoder.

CAUTION: The 'AV Direct' setting should only be used for surround decoders that include a volume control, as the volume control of your amplifier will be fixed at a very high level.

MC-BUS system

Connecting the MC-BUS sockets between components in a Cyrus audio system provides unified system control.

- Connect single phono cables from the MC-BUS output of one unit to the MC-BUS input of another in a daisy-chain as shown in the diagram below.
- Complete the loop by returning the MC-BUS output of the final component to the MC-BUS input of the first.

With MC-BUS connection established you can control the power function of the entire system from the front panel or remote control.

In the system below, selecting 'CD' will switch on the amplifier, the Cyrus power amplifier and a Cyrus CD player. When the amplifier is set to Standby, the entire system will switch off.

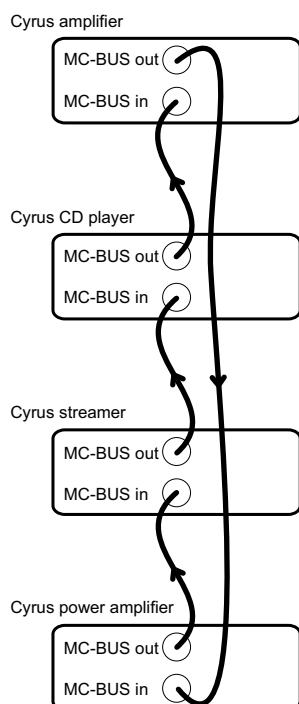

When a Cyrus surround processor is included in the MC-BUS loop, setting of the volume calibration level will take place automatically when the 'Cyrus AV' input is set as 'Source Type'. Refer to the handbook for the surround processor for further details.

Connecting to the AC mains supply

Connect the socket on the AC Power cable to the power inlet on the rear panel of the amplifier. Now connect the cable to a suitable AC power point.

NOTE: The means to disconnect this product from the mains supply is the mains plug. Ensure that the mains plug is accessible at all times.

Operation

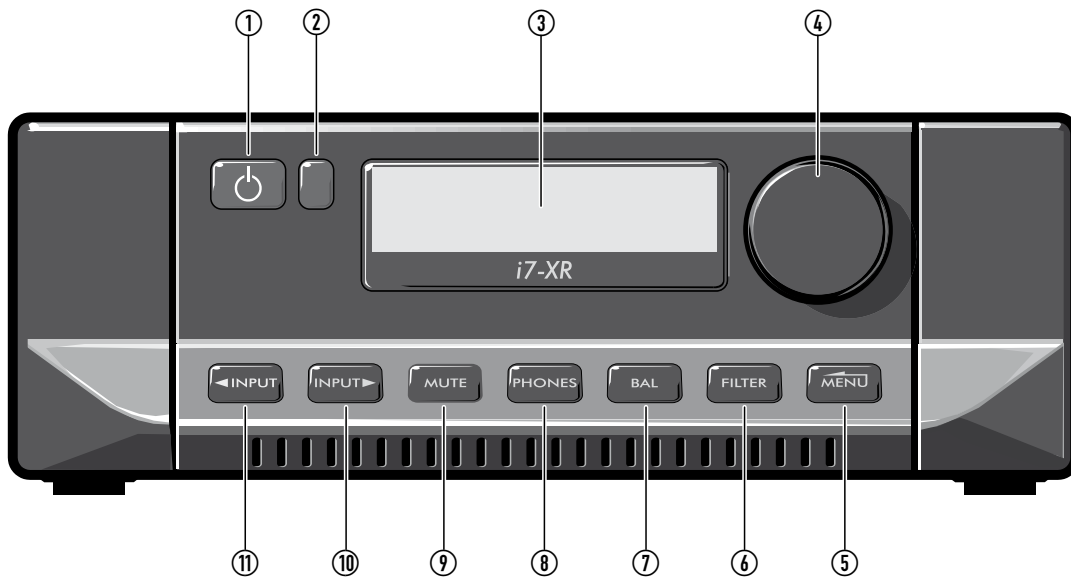

Key to the front panel drawing

- | | |
|-----------------------------------|--------------------|
| 1. Standby and indicator | 7. Balance |
| 2. Remote eye | 8. Headphones |
| 3. Display window | 9. Mute |
| 4. Level control and setup adjust | 10. Next input |
| 5. Menu | 11. Previous input |
| 6. Filter | |

Touch pad controls

The front panel controls are touch sensitive. There is no need to press the controls, just lightly touch or hold a finger on the touchpad to select a function.

Power

Mains power

In regular use mains power can be left connected permanently.

When unattended for a long period (holidays etc) mains power should be disconnected.

Standby

When mains power is connected, the standby touchpad (⏻) is used for power control.

When switched on the ⏻ touchpad colour can be set from the options available in the setup menu (default setting is white).

When in standby, the ⏻ touchpad colour will be red.

When set to standby, all settings in use are retained.

Auto-standby

To save energy, standby will set automatically 20 minutes after music last played. If required, the auto-standby feature may be disabled in the setup menu.

Selecting an input

Inputs may be selected from the front panel touchpads.

- Touch 'INPUT▶' or '◀INPUT'.
- The input names will step through on the display.

Inputs set with 'Cyrus AV' or 'AV Direct' response

Inputs may have been set with an MC-BUS/AV setting of 'Cyrus AV' or 'AV Direct'. These settings are for use with surround-sound decoders. When one of these inputs is selected, the amplifier is configured as a power amplifier with fixed gain for the selected input. This enables the surround decoder to share the front left and right speaker channels of a Cyrus stereo system.

The volume control on the amplifier will be locked at -6dB and mute will be disabled.

When in one of these AV modes, the surround decoder input select and volume controls are used to select a multi-channel source and set the volume level for the system.

When the source is changed from a Cyrus AV or AV Direct source, the volume control will unlock and return to the level last in use.

Playing USB audio from a computer

Windows computers will require the installation of a USB audio driver. This is available for download from the Cyrus website. Mac OS computers do not require driver installation.

With the driver installed and a USB connection in place, USB audio can be played.

Playing DSD audio from a computer

Playback of DSD files will require the installation on the computer of a specialist music playback app that supports DSD playback.

- Before playing DSD music, choose, install and configure a DSD player app on a computer connected to the 'USB B' input.
- Select the 'USB' input.
- Play the DSD music file.

Volume level and channel balance

The level control performs the dual functions of volume and balance.

Volume

- Turn the level control to set the volume in 1dB steps.
The volume level is shown numerically in dB at the right side of the display.

Headphone volume

When headphones are playing, headphone volume level is set and stored separately to speaker volume level. When switching between headphone and speaker operation the last used volume level setting for headphones or speakers will be recalled.

Safe volume levels after standby

The last used volume level settings for both speakers and headphones are stored when the unit is set to standby. If either or both volume settings are set to an abnormally high level (greater than -30dB) before entering standby, the level will be reduced automatically to a safer level of -30dB for next use.

Balance

- Touch 'BAL' to change the mode of the front panel level control to set Left/Right channel balance.
The display will change to show a graphic display of the balance setting.

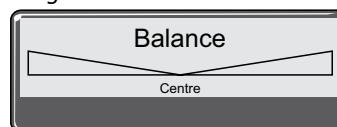

The default central position is shown in this example.

- Adjust the channel balance in 1 dB steps by up to 5dB toward the left or right channels by turning the level control.

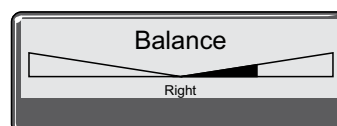

Balance set 3dB towards the right is shown in this example.

After the 5dB setting, one further step will swing the sound balance completely to the left or right speaker. This setting may be useful when checking if the system channels are working correctly etc.

Balance can also be set by remote control.

Mute

- Touch 'MUTE' to mute the volume to minimum level without disturbing the existing volume setting.
When muted the volume level display will show that the sound is muted.
- Touch 'MUTE' again to restore the original volume setting.

Headphones

- Connect your headphones.
- Touch 'PHONES'.
The volume level display will switch from 'dB' indication to show a headphone symbol, the sound will mute in the speakers, and switch to the headphones. To return to speaker operation, touch 'PHONES' again.

Note: Headphones can only be selected when headphones are connected to the rear panel socket.

Warning: Excessive sound pressure from earphones and headphones can cause hearing loss.

Filter

The Filter function provides the option to select different digital filtering alignments for the internal D/A converter stage. Changing the filter alignment will make subtle changes to the sound of digital sources. The best setting to use will depend on factors such as the sample rate of the recording and the technology used when the recording was made. For that reason, different filter settings may be required to get the best results for different sources, recordings and formats. The default setting provided is chosen for the best all-round performance.

- Touch 'FILTER' repeatedly to step through the available options.

The filter name will be displayed and the filter setting updated.

NOTE: The filter setting will not affect the sound of analogue inputs.

The filter setting can also be set by remote control via the settings menu.

Filter settings

Digital filters are required to minimise unwanted antialiasing distortion in the audio band, but no digital filter is perfect, all are a compromise between various parameters.

Seven filter settings are available, described in this section.

Brick Wall

No phase shift, but introduces both pre- and post-ringing artefacts.

Corrected Minimum Phase Fast Roll Off (Hybrid)

Low pre-ringing and the phase response varies at higher frequencies. There is more post-ringing than compared with linear phase and apodizing filters.

Apodising (default)

A compromise between phase, frequency response and ringing. Its main advantage is that it removes most of the ringing that has been introduced as part of the recording process when the original material was recorded and mastered.

Minimum Phase, Slow Roll Off (Gentle/Minimum)

No pre-ringing artefacts but can introduce phase shifts at higher frequencies. It has less post-ringing than the Minimum Phase Fast Roll Off, but this is still higher than the linear phase filter options. Very high frequencies in the last half octave of the filter pass band will be slightly attenuated.

Minimum Phase, Fast Roll Off (Steep/Minimum)

No pre-ringing and the phase response varies at higher frequencies. There are much higher amounts of post ringing than compared with the linear phase filter options.

Linear Phase Slow, Roll Off (Gentle/Linear)

Low and equal levels of pre- and post-ringing. No phase shift but can introduce high frequency aliasing at a higher level than linear phase, fast roll off. Very high frequencies will be slightly attenuated.

Linear Phase, Fast Roll Off (Steep/Linear)

Higher and equal levels of pre- and post-ringing compared with linear phase, slow roll off. No phase shifts and with minimal high frequency aliasing compared with minimum phase, slow roll off.

Digital filter terms

The terms used to describe the behaviour of the digital filters in the previous section include:

Frequency response

Audio level vs. frequency. This should be effectively flat between 20Hz and 20kHz.

Phase

The time delay introduced between reproducing different frequencies that pass through the filter. Ideally this would be as low as possible which would give a linear phase vs. frequency or constant group delay.

Pre-ringing

Audio artefacts that precede the original audio impulse. These are normally undesirable as this phenomenon does not exist in the natural world, so ideally this should be minimised.

Post-ringing

Audio artefacts that follow the original audio impulse. Ideally these should be minimised, but are not normally as detrimental as pre-ringing artefacts.

Aliasing

Audio artefacts introduced into the audio band from high frequency signals.

Tape playback and recording

Playback

You can play back a recording by selecting the input to which you connected your tape recorder.

Recording

If you have connected the 'Fixed Out' sockets to the input of your tape recorder, you can make recordings from the input sources connected to your amplifier.

The recording signal will always track the source that is playing. If the source is changed then the recording source from 'Fixed Out' will also change.

NOTE: Avoid selecting the tape playback input when recording. This will cause a feedback howl.

Playing through a second amplifier

If you have a second amplifier connected to fixed out, the second amplifier will play the selected source from the main system.

Volume for the second system is controlled by the second amplifier.

NOTE: The fixed output will be muted when the amplifier is muted and during headphone operation.

Remote control operation

Remote control introduction

The iR14 remote control will send commands to Cyrus amplifiers, CD players and audio streamers*.

The remote control can also be programmed with the commands from two other remote control handsets. These will normally be for your TV and a satellite receiver, programmed to the TV and SAT buttons, but could also be other audio components.

*NOTE: It may be necessary to upgrade the firmware in an audio streamer to enable infra-red remote control operation.

Remote control backlight

The remote control keypad includes a back-light. The back-light will switch on automatically when moved or when a command is sent.

Fitting batteries to the remote control

The battery compartment is on the back of the remote control.

1. Press the catch on the battery cover and lift off the cover.
2. Slide a AAA battery under the retaining hook in the upper half of the battery compartment as shown.
3. Fit a second AAA battery into the remaining space.
4. Replace the battery cover.

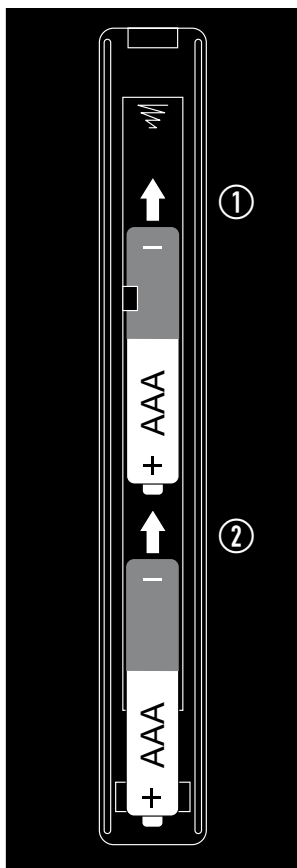

Replace the handset batteries only with AAA batteries of the same voltage and type.

Discard used batteries in accordance with recycling regulations in force in your area.

Sending commands to Cyrus components

- Press the CYRUS key to switch on a Cyrus amplifier. The remote control will now send commands to a Cyrus amplifier.

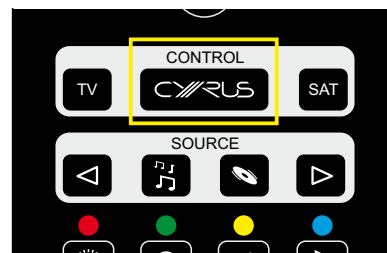

Switching on Cyrus source components

- Press the SOURCE key to switch on a Cyrus CD player and send commands to the CD player and an amplifier.

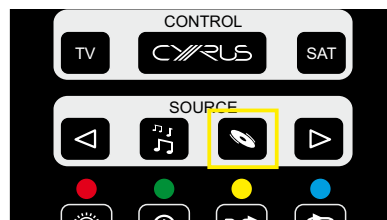

NOTE: If an amplifier input has been named CD, the amplifier will switch on, set to the correct input.

- Press the MUSIC key to switch on a Cyrus audio streamer and send commands to the streamer and an amplifier.

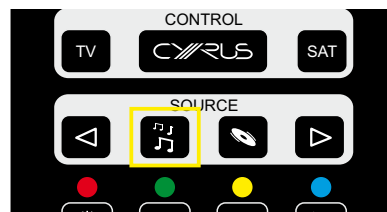

Cyrus amplifier commands

- Press the CYRUS key to set the remote control to Cyrus amplifier mode.

You can now control a Cyrus amplifier. The CYRUS key will flash red when commands are being sent in Amplifier mode.

NOTE: Commands marked * are for Cyrus XR series amplifiers only, other Cyrus amplifiers will not respond to these commands.

Amplifier mode commands available are listed below –

- Set Cyrus amplifiers, CD players and audio streamers to standby.
- Set the handset to send commands to Cyrus components.
- Send commands to a satellite receiver (or other device programmed to use this key).
- Set the handset to send commands to an amplifier and CD player. Select an input named CD.
- Step to the next amplifier input.
- No command for an amplifier.
- No command for an amplifier.
- Jump to the 'About' menu*.
- Step up menu options*.
- Step down menu options*.
- Step down menu options*.
- Open menu/select menu option*.
- Amplifier mute.
- Step to the next amplifier input*.
- Step to the previous amplifier input*.
- Open menu/select menu option*.
- No command for an amplifier.
- No command for an amplifier.
- No command for an amplifier.
- No command for an amplifier.
- No command for an amplifier.
- Setup key for programming TV/SAT keys.
- No command for an amplifier.
- No command for an amplifier.
- No command for an amplifier.
- No command for an amplifier.
- No command for an amplifier.
- No command for an amplifier.
- No command for an amplifier.
- Volume down.
- Volume up.
- Balance.
- Step back in menu tree*.
- Step up menu options*.
- Open menu/select menu option*.
- Menu home page*.

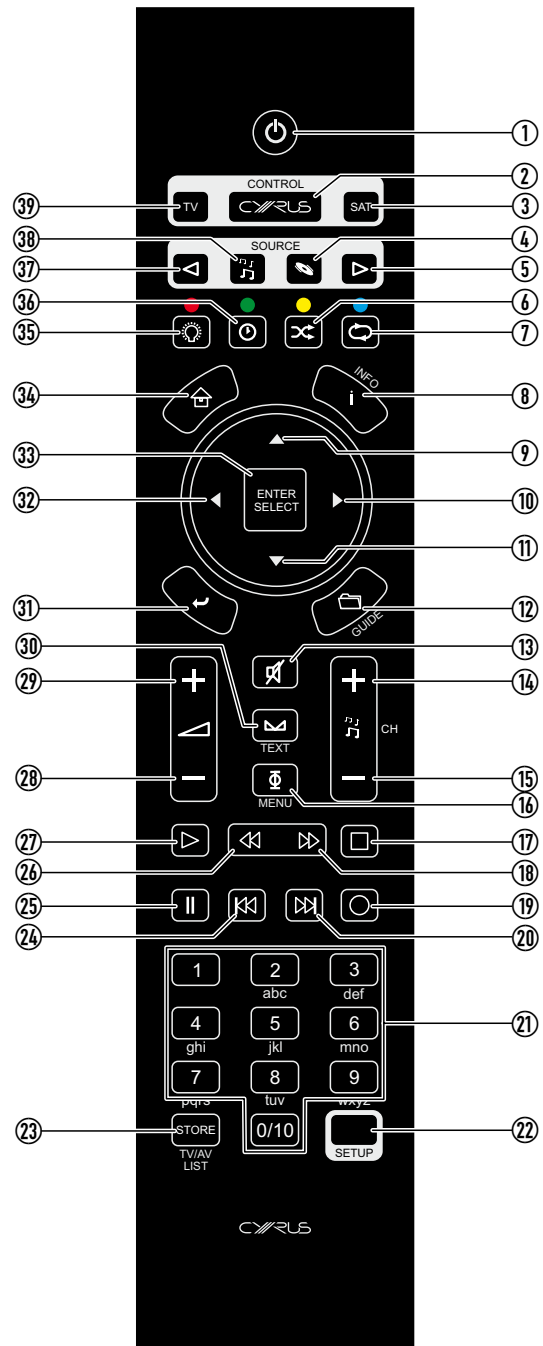

- Display off.
- No command for an amplifier.
- Step to the previous input.
- Set the handset to send commands to an amplifier and audio streamer.
- Send commands to a TV (or other device programmed to use this key).

Cyrus CD player commands

- Press the CYRUS key
- Press the  key to set the remote control to CD mode.

The key will light red. You can now control both a Cyrus CD player and amplifier. The  key will flash red when commands are being sent in CD mode.

NOTE: Commands marked * are for Cyrus XR series CD players only, other Cyrus CD players will not respond to these commands.

The CD mode commands available are listed below –

1. Set Cyrus amplifiers, CD players and audio streamers to Standby.
2. Set the handset to send commands to an amplifier.
3. Send commands to a satellite receiver (or other device programmed to use this key).
4. Set the handset to send commands to an amplifier and CD player. Select an input named CD.
5. Step to the next amplifier input.
6. No command for a CD player.
7. CD player repeat.
8. Jump to the 'About' menu*.
9. CD player next track/step up menu options*.
10. CD player search forwards/step down menu options*.
11. CD player previous track/step down menu options*.
12. Open menu/select menu option*.
13. Amplifier mute.
14. No command for a CD player.
15. No command for a CD player.
16. CD player audio phase.

Changes in phase are subtle and are best established from the listening position. When the phase setting is changed, the display text area will show the message 'Phase Normal' or 'Phase Invert'. The performance of the CD player is unaffected whether the signal is in normal or phase inverted mode.

17. CD player stop.
18. CD player search forwards.
19. No command for a CD player.
20. CD player next track.
21. CD player numeric keypad.

Enter a one or two digit track number to jump to a specific track.

22. Setup key for programming TV/SAT keys.
23. CD player memory store.
24. CD player previous track.
25. CD player pause.
26. CD player search back.
27. CD player play/pause.
28. Amplifier volume down.
29. Amplifier volume up.

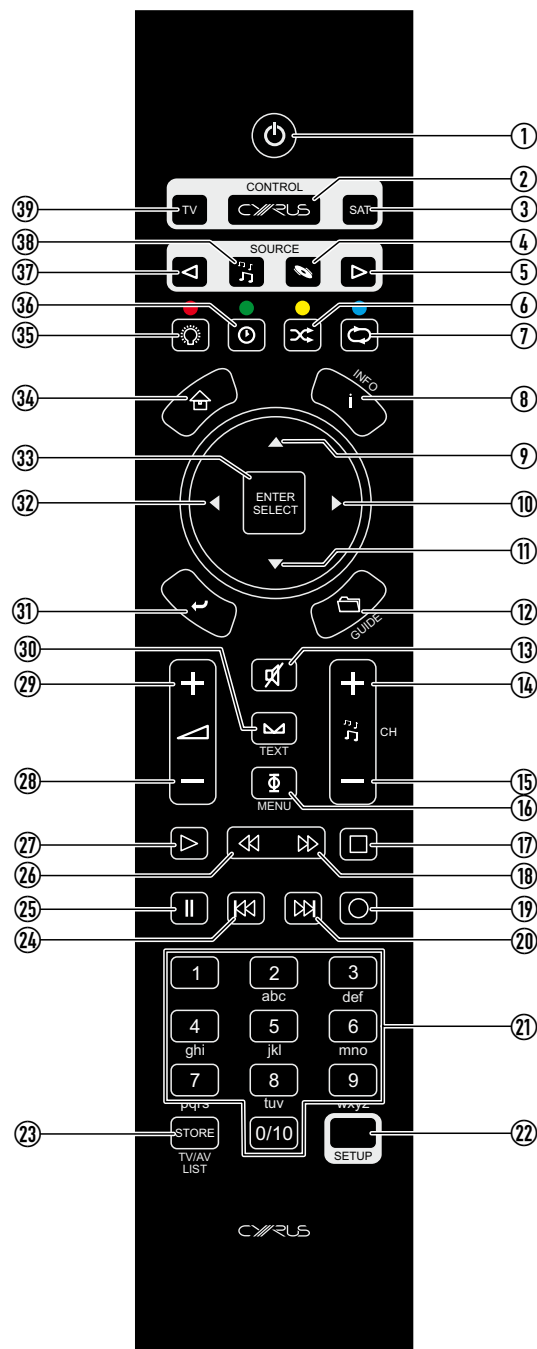

30. Amplifier balance.
31. Step back in menu tree*.
32. Step up menu options*.
33. No command for a CD player.
34. Menu home page*.
35. CD player display off.
36. CD player display mode.
Choose track elapsed time or disc remaining time.
37. Step to the previous amplifier input.
38. Set the handset to send commands to an amplifier and Audio streamer.
39. Send commands to a TV (or other device programmed to use this key).

Cyrus audio streamer commands

- Press the CYRUS key
- Press the  key to set the remote control to audio streamer mode.

The key will light red. You can now control both a Cyrus audio streamer and amplifier or an audio streamer that includes an amplifier. The  key will flash red when commands are being sent in audio streamer mode.

The audio streamer mode commands available are listed below –

1. Set Cyrus amplifiers, CD players and audio streamers to Standby.
2. Set the handset to send commands to a Cyrus amplifier.
3. Send commands to a satellite receiver (or other device programmed to use this key).
4. Set the handset to send commands to an amplifier and CD player. Select an input named CD.
5. Step to the next amplifier input.
6. No command for an audio streamer.
7. Audio streamer repeat.
8. Audio streamer display information.
9. Audio streamer cursor up.
10. Audio streamer cursor right.
11. Audio streamer cursor down.
12. No command for an audio streamer.
13. Amplifier mute.
14. No command for an audio streamer.
15. No command for an audio streamer.
16. No command for an audio streamer.
17. Audio streamer stop.
18. No command for an audio streamer.
19. No command for an audio streamer.
20. Audio streamer next track.
21. Audio streamer alpha-numeric keypad.
22. Setup key for programming TV/SAT keys.
23. No command for an audio streamer.
24. Audio streamer previous track.
25. Audio streamer pause.
26. No command for an audio streamer.
27. Audio streamer play/pause.
28. Amplifier volume down.
29. Amplifier volume up.
30. Amplifier balance.
31. Audio streamer back.
32. Audio streamer cursor left.
33. Audio streamer select.
34. Audio streamer home.
35. Audio streamer display off.
36. No command for an audio streamer.
37. Step to the previous amplifier input.

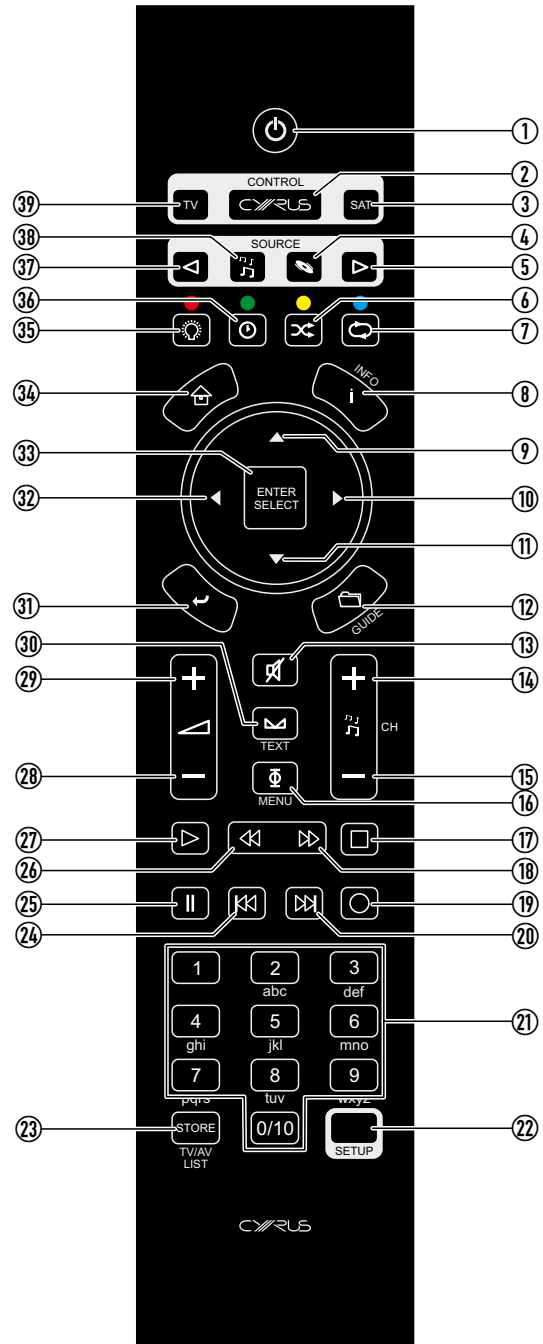

38. Set the handset to send commands to an amplifier and audio streamer.

39. Send commands to a TV (or other device programmed to use this key).

Cyrus Phono Signature commands

Commands are sent to the Phono Signature via keys reserved from the amplifier control system.

The remote control operates in the same way as the front panel controls - press a key to select a function, change that setting with the 'CURSOR' keys, confirm the setting with 'ENTER/SELECT'.

This page lists commands that will control the Phono Signature.

- Press the CYRUS key to set the remote control to Cyrus mode.

You can now control both a Cyrus amplifier and the Phono Signature. The CYRUS key will flash red when commands are being sent in this mode.

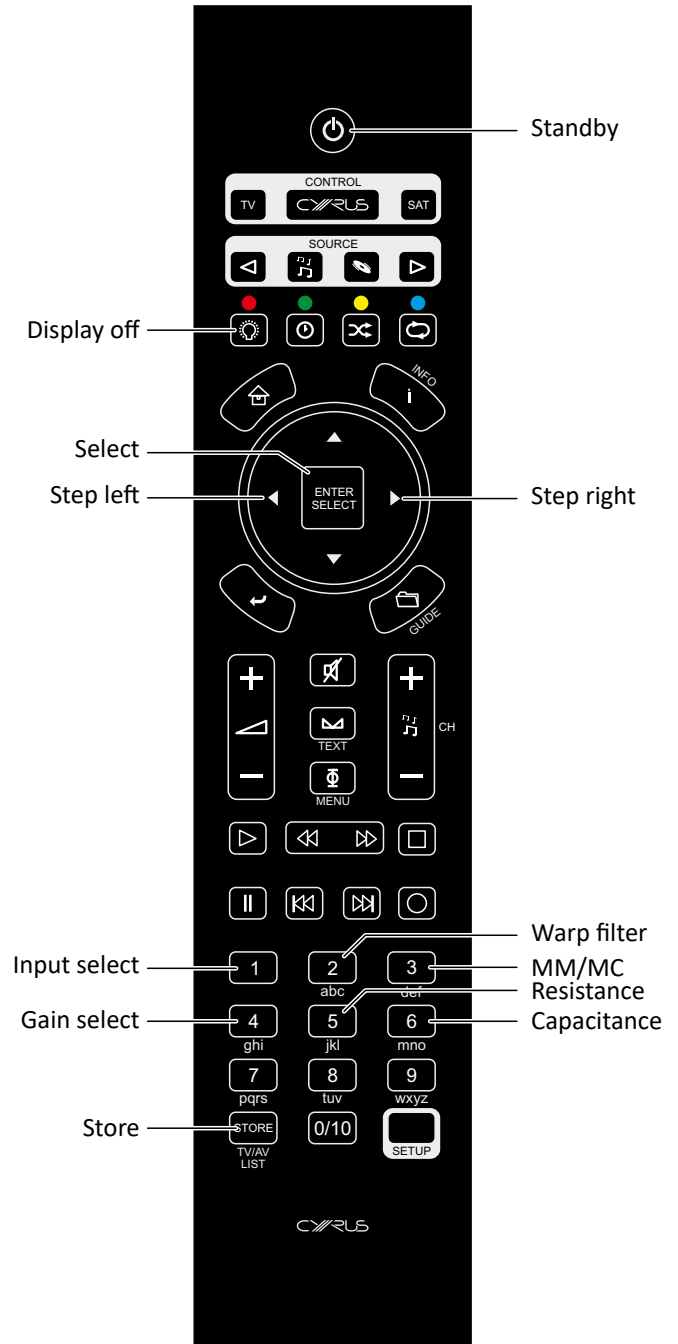

Setup menus

Setup menus enable extensive customisation of the user interface.

Setup options

The next two pages show a map of the menu options available.



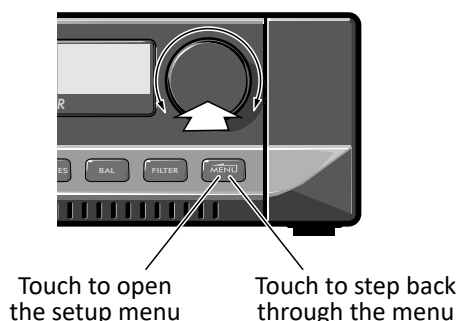

Navigating the menu from the front panel

- Touch **MENU** to open the settings menu.
- Turn the rotary control to step through the available options.
- Press the rotary control to select an option.
- Touch **MENU** to step back through the menu without making any changes.

Turn to step through menu options, push to select an option



Navigating the menu from the remote control

- Press  to open the menu home page.
- Press  or  to step through the available options.
- Press  to select an option.
- Press  to step back through the menu without making any changes.

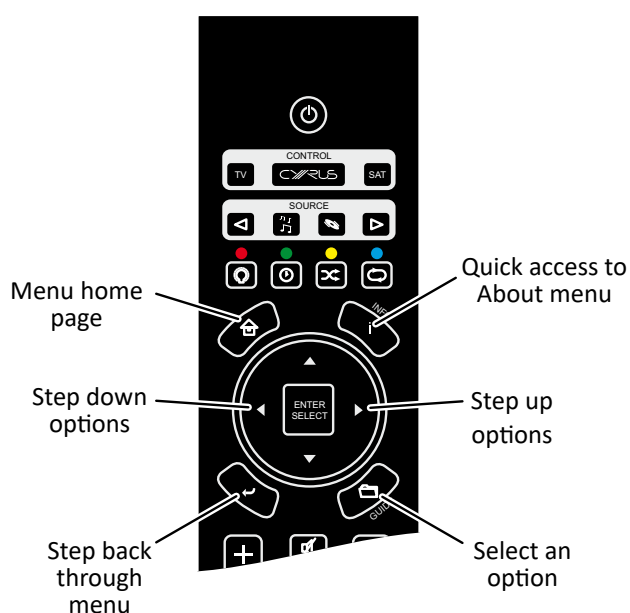

Menu maps

Setup

→ General

→ Default Input

↳ Select an input from the list

*Sets the default input that will select whenever the amplifier is connected to mains power.
NOTE: When exiting standby the amplifier will re-select the last-used input, not the default.*

→ Headphones

→ Auto Select

The amplifier will switch between headphone and speaker operation when headphones are connected/unplugged. If headphones are permanently connected it is still possible to switch between headphone and speaker operation manually by touching 'PHONES' on the front panel.

→ Manual

Headphone operation can only be selected manually. Switch between headphone and speaker operation by touching 'PHONES' on the front panel.

→ Balance

Enables left/right channel balance adjustment. This is the same function that is available via the quick-access balance adjust keys on the front panel and remote control. Refer to the 'Balance' section for more detail.

→ Auto Standby

Auto Standby is an energy saving feature. After a 20 minute period of inactivity (no music playing, sound muted etc) standby will be set automatically to reduce energy consumption. If required, Auto Standby may be disabled by selecting this option.

→ DAC Filter

Enables selection of different digital filter options for the DAC stage. This is the same function that is available via the quick-access 'FILTER' touchpad on the front panel. Refer to the 'Filter' section for more detail.

→ Input

↳ Select an input to configure

→ Name

*Change the name of the selected input. Choose a name from the list provided.
NOTE: The name chosen will not change the MC-BUS response of the selected input. The MC-BUS response can be changed separately via the 'MC-BUS/AV' menu option.*

→ MC-BUS/AV

*Change the source type of the selected input. Setting this option will determine how the selected input will respond to MC-BUS commands. For example, if an input source type is set to 'Streamer', and the system is cabled for MC-BUS control, a connected Cyrus streamer will switch on when that input is selected. Choose 'Unspecified' to disable MC-BUS from the selected input.
NOTE: The source type selected will not change the name of the input. The input name can be changed separately via the Name menu option.*

→ Volume Offset

Change the volume offset for the selected input. Volume offset is an option that can equalise the volume of all the connected sources by reducing the volume level for louder sources or increasing the volume of quieter sources.

→ Max Vol

The 'Max Vol' option enables a volume limit to be set for the selected input when listening via speakers. Once set, the volume control cannot be increased beyond the set limit. To limit the volume setting available from all inputs, each will need to be set individually.

→ Max HP Vol

The 'Max HP Vol' option enables a volume limit to be set for the selected input when listening via headphones. Once set, the volume control cannot be increased beyond the set limit. To limit the volume setting available from all inputs, each will need to be set individually.

→ Enabled

This option enables unused inputs to be removed from the input list.

→ Display ---> See the next page for 'Display' menu options

→ System ---> See the next page for 'System' menu options

Menu maps

Setup

→ General -- → *See the previous page for 'General' menu options*

→ Input ---- → *See the previous page for 'Input' menu options*

→ Display

→ Display Polarity

Sets the display polarity to positive (dark characters on a light background) or negative (light characters on a dark background).

→ Display Contrast

Sets the contrast of the display in the range -10 to +10. Factory default setting is 0.

→ Display Brightness

Sets the brightness of the display in the range Level 1 to Level 5. Factory default setting is Level 5.

→ LED brightness

Sets the brightness of the standby indicator in the range Level 1 to Level 5. Factory default setting is Level 5.

→ LED Mode

Sets the colour of the standby indicator. Choose from XR (white), Green or Classic (to match other Cyrus units). Factory default setting is XR.

→ System

→ Factory Reset

This option will return all user settings to the factory defaults. After selecting this option you will need to confirm you want to go ahead by selecting 'Yes' from the sub-menu. Factory reset cannot be undone.

→ About

This option displays information about the firmware of the unit including model name, firmware version and release date.

Firmware updates

The operational firmware may be upgraded from time to time to add new features and to fix operational issues.

New firmware versions will be available from the 'Support' pages of the Cyrus website www.cyrusaudio.com.

If new firmware is available, this will be packaged with other documents including -

- Firmware version change log.
- Latest firmware update procedure.
- Revised handbook (if required).

Remote control learning

In addition to controlling Cyrus components, the remote control can learn the commands from two other remote control handsets. These will normally be a TV and a satellite or terrestrial TV receiver, programmed to the 'TV' and 'SAT' buttons, but could also be other audio components.

All keys may be programmed with the exception of the groups marked 'CONTROL' and 'SOURCE' and the 'SETUP' key.

Preparation for learning

Check the following points before attempting to learn any commands -

- Check that both remote controls have fresh batteries.
- Choose a location on a tabletop that is not brightly lit. Subdued light is better, away from bright natural or indoor lighting.
- Check that you have enough time to spare to complete the learning process for all the keys you want to use.

Learning commands

In this example, the Cyrus remote control will be learning commands from a 'reference' satellite receiver remote control.

1. Set the two remote controls up facing each other, spaced by about 5cm.

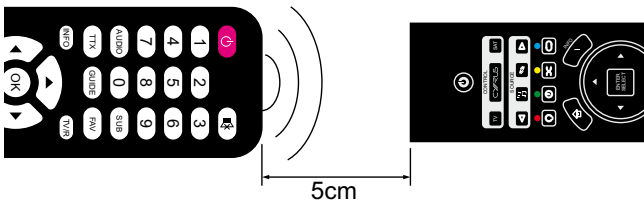

2. Press the 'TV' or 'SAT' key to select the mode that you want to program.

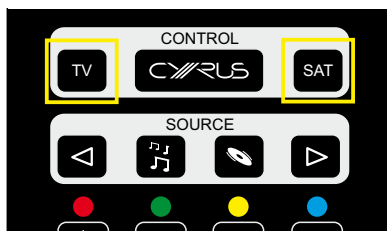

The keypad will light and the key you selected will be red.

3. Press and hold the 'SETUP' key.



The mode key will change to white. After about three seconds, the mode key will light red again. This indicates that the remote control is ready to learn codes.

4. Release the 'SETUP' key.

The remote control is now waiting to learn commands. The keypad will light continually and the mode key will light pale red.

5. On the reference remote control, press and hold the first key you want to learn (for example, volume up) until the mode key flashes red.

This indicates that the command has been received.

6. Release the key on the reference remote control.

7. Press a key on the Cyrus remote control (volume up in this example) to select where you want to save that command.

The mode key will stop flashing. This indicates that the command has been saved successfully.

If the learning process was successful, the remote control will be ready to learn the next command.

8. Repeat steps 5 to 7 for each command you want to learn.

When you have completed learning all commands -

- Press the 'SETUP' key.

The mode key will change to white. After a few seconds the backlight will switch off.

Checking programmed commands

- Select the mode that you just programmed and check that the commands were learned successfully.

NOTE: The 'TV' or 'SAT' mode key should flash red when sending a command. If the mode key is not flashing, then the command has not learned correctly.

- Make a note of any commands that have not programmed correctly and repeat the learning process to add these in.

NOTE: When you start the learning process it does not erase any programmed keys so you can re-program individual keys if required.

Problems with learning

If none of the commands have learned correctly, try re-starting the learning process again. Test a few keys first to ensure that your handset is compatible for learning. If the test works then continue to program the rest of the commands you need.

If you still have problems, check carefully that the mode light is flashing correctly as you send a command to learn. If not, it may be that the batteries need replacement in the reference handset or that the spacing between the handsets is not ideal. Try adjusting the spacing between the handsets and repeating the learning process.

If you continue to have problems, it may be that your handset is incompatible with the learning process. This could happen with an older design of handset or one that has an unusual code-set.

Sending TV or SAT commands

Once you have programmed all the keys with the commands you want, you can use the remote control to send commands to your TV or Satellite receiver etc.

- Press the 'TV' or 'SAT' key to select the mode you want.
- Press the command key.

The mode key will flash red when sending a programmed command.

Troubleshooting guide

If your amplifier is not operating properly, disconnect the power and check carefully all connections.

If you are in any doubt, consult your retailer.

No sound	
The amplifier is switched off or in standby (indicator is red).	Bring the unit out of standby.
Mute is on	Deselect mute
The source is not working (e.g. CD not playing or paused).	Check the source.
No sound (digital sources)	
The sample rate or sound format of the digital signal from the source may not be correct.	Check that the sample rate from the source is within the specification of the amplifier and that the program is encoded as two channel stereo.
Computer not recognising USB	
The computer may require installation of a driver, or an update to an existing driver.	The latest driver can be downloaded from the Cyrus website. Install the driver and check the input with USB audio again.
No sound from one loudspeaker	
Balance control at extreme limit.	Centralise balance.
Does your speaker have fuses?	Check speaker, replace fuses.
Speaker cables / interconnects faulty.	Check connections, cables - replace if needed.
Spurious noises from speakers	
Interconnects or connections faulty.	Check, replace where necessary.
Standby is activated randomly	
Auto standby may have operated.	To save energy, the unit will automatically set to standby if no music plays for 20 minutes.
Remote control not operating	
The batteries may be flat.	Check the batteries.
Remote control lights flash	
This indicates that the batteries are flat.	Replace the batteries.

Error indication

Your amplifier has a unique error indication system to help you to diagnose problems. If an error is detected in use, the display will show 'Error' with indication of the type of error as shown in the table.

Mains	
The mains supply voltage has been outside of safe limits.	Disconnect the amplifier from mains power and re-connect it. If the fault persists arrange for an electrician to check the mains supply voltage.
Amp Over Current	
The amplifier output has been overloaded. This is usually due to a short-circuit at the loudspeaker terminals.	Switch off the amplifier and check that there are no short circuits in the speaker wiring at the amplifier rear panel or at the speaker terminals.
Thermal	
The amplifier has over-heated. This may occur if the amplifier is driving low impedance speakers, if the volume is set too high for prolonged listening, or if there is inadequate ventilation for the amplifier.	The amplifier will switch off until it has cooled down. If this happens regularly, try improving the ventilation around the casing of the amplifier. If the problem continues, then the impedance rating of your speakers may be too low.
Internal PSU fault	
This fault condition will be displayed if there is a fault with the internal power supply of the amplifier.	A PSU fault cannot be corrected by the user. The amplifier should be returned to your retailer.

If a fault condition still remains, return the amplifier to your Cyrus appointed retailer or an authorised Service Centre.

Specifications

Power Supply

Voltage As plate on rear of unit

Power Consumption

Standby..... <0.5W

Maximum 300W

Safety Compliance..... CE

EMC (230V)..... CE

EMC (115V)..... FCC

Enclosure

Size (HxWxD) ... 75 x 215 x 365 mm (2.95" x 8.46" x 14.37")

Weight 4.9kg (10.8lbs)

Material Die cast chassis

Analogue audio performance

Input sensitivity (40W/8Ω) Line..... 179mV

Input impedance Line..... 28kΩ

Frequency response (-3dB) Line..... 0.1Hz, >100kHz

Signal to noise ratio (A-WTD) Line..... 104dBA

Power output (2 channels driven) ..6 Ohms 52W

THD+N (Pre-Amp) 1kHz Line..... <0.003%

THD+N (1kHz, 2/3 power) 8 Ohms <0.003%

(both channels driven)

Digital audio performance at pre-out

Input voltage 500mV pk-pk

Input impedance 75Ω

Sample rate range (SPDIF) 16/44.1k - 24/192k

Sample rate range (USB)..... 16/44.1k - 32/384k

USB supported formats (SPDIF)..... PCM stereo

USB supported formats (DSD) up to DSD256

USB supported formats (DOP)..... up to DOP128

S/N ratio (pre-out, 0dB FS) >113dBA

THD (pre-out, 0dB FS)..... <0.001%

Cyrus reserves the right to change all specifications without notice. E &OE

Acknowledgements

This product uses the LVGL graphics library.

See <https://lvgl.io>

Warranty

The warranty period is three years. No retailer or distributor may vary the terms of this warranty, which is personal to the original purchaser and is not transferable.

Please retain the sales receipt as proof of purchase.

Warranty claims must wherever possible be made through the retailer from whom the equipment was purchased.

This warranty excludes:

- Damage caused through neglect, accident, misuse, wear and tear, or through incorrect installation, adjustment or repair by unauthorised personnel. Any unauthorised servicing will result in loss of warranty.
- Liability for damage or loss occurring in transit to or from the purchaser.
- Consequential damage, loss or injury, arising from or in conjunction with this equipment.

Equipment for attention under warranty should be consigned return carriage paid. If returned equipment is found to comply with the published specification, CYRUS reserves the right to raise a charge.

The above conditions do not affect your statutory rights as a consumer.

WEEE

This logo means that this product is not to be disposed of with your household waste. This product should be handed over to a designated collection point to be recycled. Your cooperation in the correct disposal of this product will contribute to the effective usage of natural resources. For more information on collection points, contact your local government for more information about recycling.





BUILDING A BETTER
MUSIC EXPERIENCE

www.cyrusaudio.com



Cyrus Audio Ltd., Ermine Business Park, Huntingdon, PE29 6XY, U.K.

v2.3