

MKC60

2-Way Coaxial Loudspeaker

- ▶ Highly Versatile, compact coaxial loudspeaker
- ▶ 1 in Dome tweeter provides superior dispersion, fidelity and output
- ▶ Flexible accessory solutions for wall, ceiling or pole mount applications
- ▶ Weather protection and transformer options
- ▶ Companion UX4401 Amplifier



OVERVIEW

The MKC series represents a major evolution of coaxial loudspeakers. Available as standard in black or white, the MKC series offers a full-suite of driver sizes allowing the series to span a powerful index of installation applications and configurations. The enclosures can be deployed in either horizontal or vertical orientations through the use of a pan & tilt wall bracket. Other deployment options include a ceiling bracket and mic stand mount.

With an innovative new port design and top of the line 1 in dome tweeter, MKC60 offers pristine audio output, similar to that of a professional studio monitor.

TECHNOLOGIES



Beamwidth Matched Crossovers Introduced over a decade ago for our MK series loudspeakers, EAW Engineers use carefully-designed HF horns and crossovers to eliminate polar irregularities through the crossover point.



Focusing™ Use of advanced digital signal processing to perfect the impulse response of a loudspeaker in the time domain. Eliminating horn "honk" and splashiness, this makes the loudspeaker sound like a studio monitor instead of a "PA" speaker.



DynO™ Dynamic Optimization actively tracks input spectrum and power delivery, continually wicking maximizing output and fidelity at any drive level.



Symmetry of Sources™ Symmetrical arrangement of acoustic sources along a common axis for utmost consistency throughout the coverage pattern.

TECHNICAL SPECIFICATIONS

2-WAY COAXIAL LOUDSPEAKER

PERFORMANCE	
Max SPL¹ (12 dB Crest Factor)	125dB
Max SPL¹ (6 dB Crest Factor)	119dB
Operating Range²	70Hz-20kHz
Nominal Beamwidth³	110 degrees conical
Axial Sensitivity	89dB
Calculated Axial Output	113dB average, 125dB peak
Nominal Phase	±15° from ideal high-pass filter
Input Impedance	8 ohms nominal, 6.1 ohms @ 250Hz minimum
Recommended HPF	70Hz 12dB/oct
ACCELERATED LIFE TEST ⁴	
LF/HF	250W @ 8ohms
CONFIGURATION	
LF Transducer, Loading	1x6.5in cone, 1.5in VC, Vented
HF Transducer, Loading	1x1in dome tweeter, coaxial
Operating Modes	Single-Amp (LF/HF, DSP w/ EAW Focusing & DynO)
PHYSICAL	
Physical Rigging	3x pairs of M6 threaded points for pole or microphone stand mount adapters 4x M5 threaded pattern for wall or ceiling mount bracket
Dimensions (HxWxD)	12.8 x 8.2 x 8.1in (324 x 208 x 206mm)
Net Weight	10.8 lbs (4.9 kg)
Shipping Weight	Approx. 26 lbs. (11.8 kg) [Sold/Shipped in Pairs]
Mounting Accessories	Pan/Tilt Bracket (included in box) 5:1 Design factor Metal wall mount Pan/Tilt bracket Ceiling mount bracket (uses included pan/tilt bracket) Pendant Bracket U-Bracket (WP Only)
Input Connector	1x Neutrik NL4, 2-pin barrier strip

1 Calculated peak SPL at 1m with stated crest factor pink noise. Specified as whole space (free field) for full range loudspeakers, half space for subwoofers.
 2 Operating Range: Range where the processed Frequency Response stays within -10 dB SPL of the power averaged SPL within this range; measured on the geometric axis. Narrow band dips are excepted.
 3 Nominal Beamwidth: Design angle for the -6 dB SPL points, referenced to 0 dB SPL as the highest level.
 4 Accelerated Life Test: Maximum test input voltage applied with an EIA-426B defined spectrum; measured with recommended signal processing and Recommended Protection Filter.

INPUT

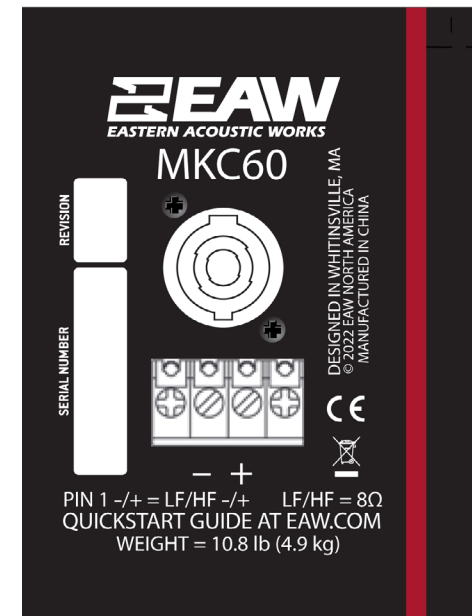

SIGNAL

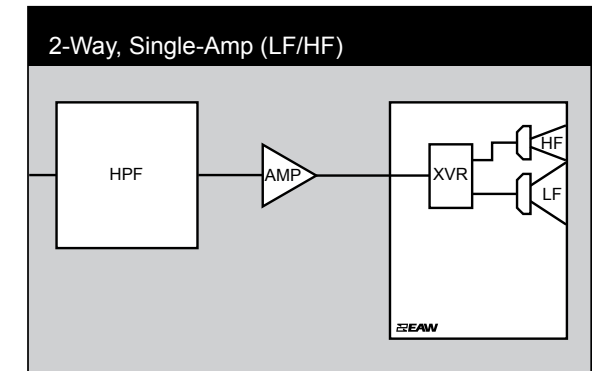

LEGEND

- LF/MF/HF:** Low Frequency / Mid Frequency / High Frequency.
- AMP:** User Supplied Power Amplifier –or– Integral Amplifier for NT products.
- XVR:** Passive LPFs, HPFs, and EQ integral to the loudspeaker.
- EAW Focusing:** Digital Signal Processor capable of implementing EAW Focusing.

TRANSFORMER SWITCH

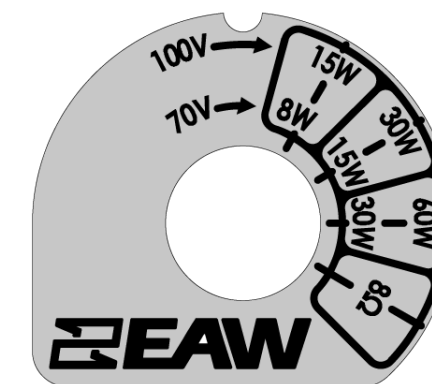

The transformer switch is accessible from the front of speaker (located behind logo on grill). Clockwise is higher power taps, counterclockwise for lower power taps.

RECOMMENDED AMPLIFIER CONFIGURATION

SINGLE-AMP



MODEL	PER CHANNEL	PER AMPLIFIER
UXA4401	1	4
UXA4403	4	16

EAW strongly recommends utilizing the processing setting to take full advantage of your speakers. Pair with EAW UXA Amps for the best performance of EAW Core Technologies

RIGGING CONFIGURATION

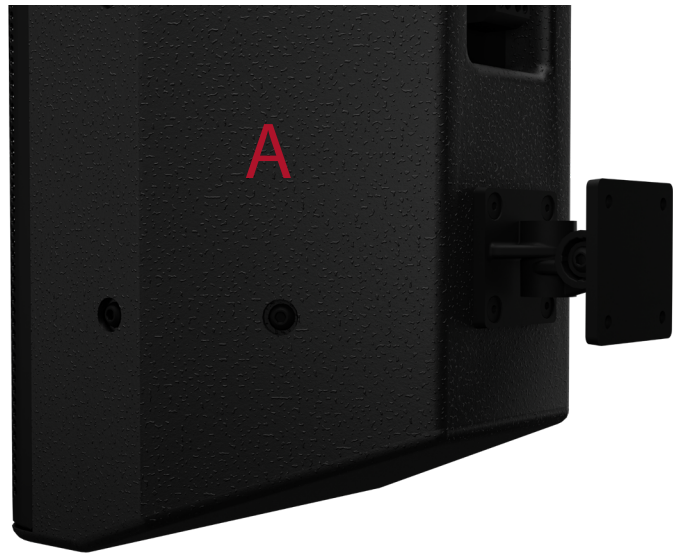

MOUNTING HARDWARE

EAW

DESCRIPTION	PART NUMBER
Pan & Tilt Bracket (A)	(shipped with product)
Ceiling Bracket	2072229-90, 2072230-90
WP U-Bracket	2071718-90, 2071788-90
Pendant Bracket (B)	2072260

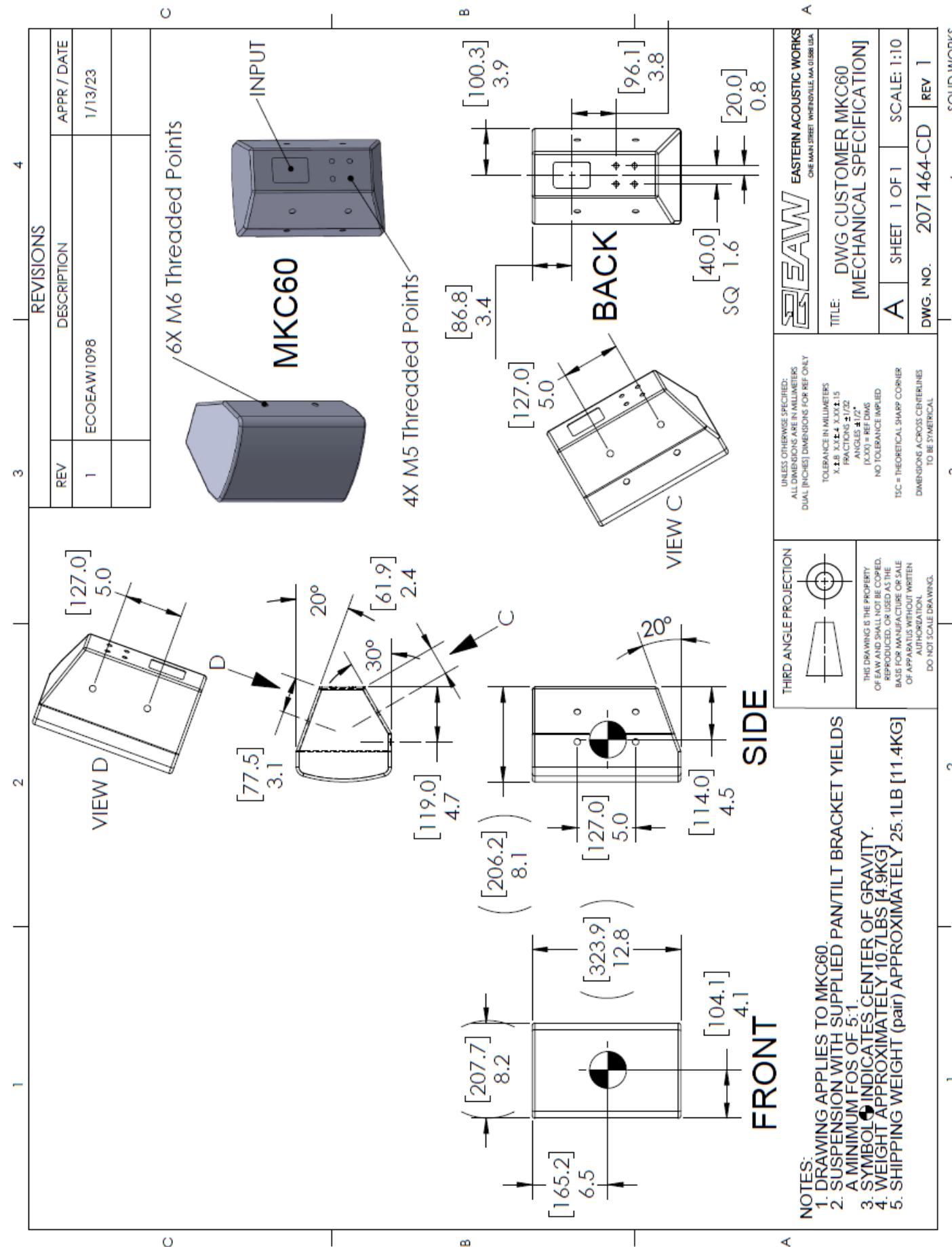
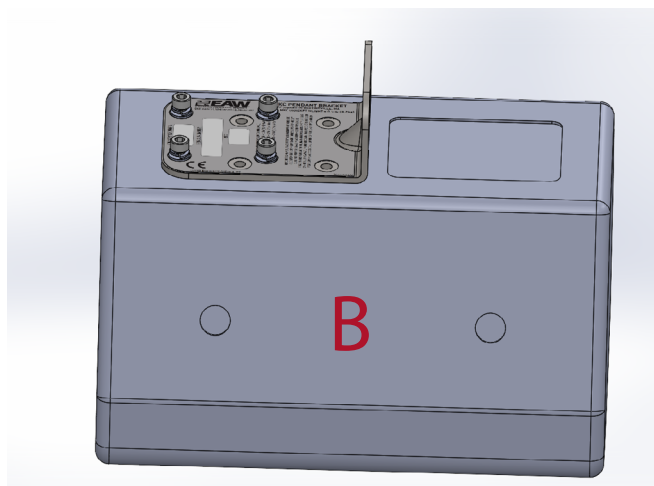

PERFORMANCE GRAPHS

FREQUENCY¹ ■=Overall Response Unprocessed

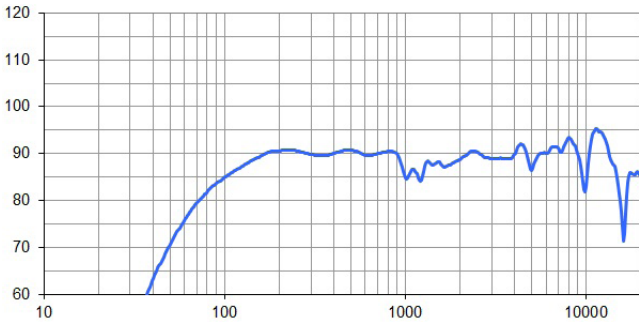

FREQUENCY¹ ■=Overall Response Processed

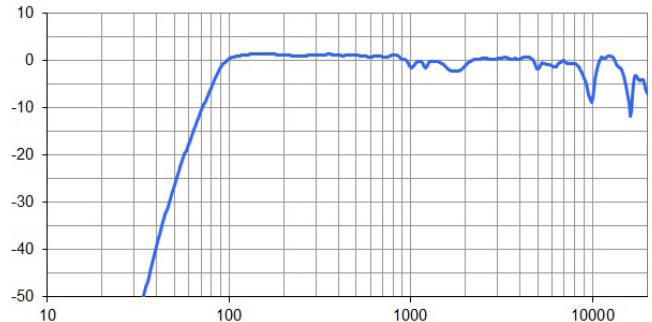

PHASE LINEARITY

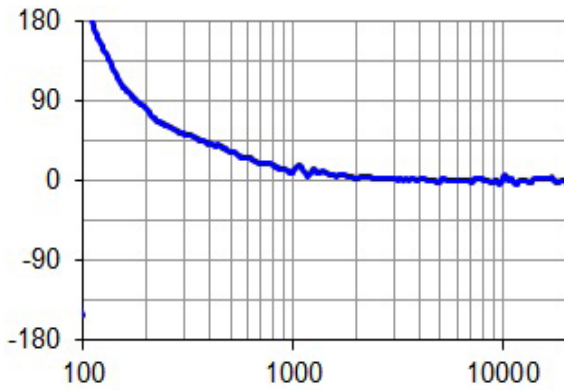

BEAMWIDTH² ■=Horizontal ■=Vertical

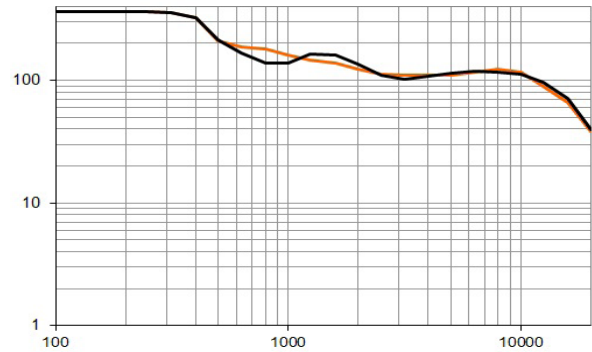

IMPEDANCE

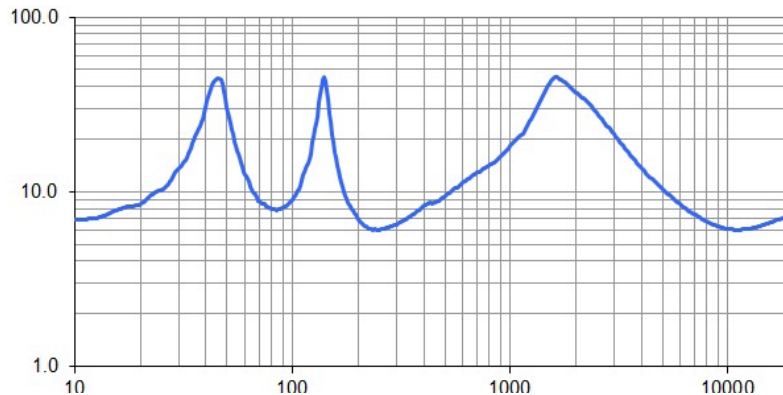

1 Variation in acoustic output level with frequency for a constant input signal. Processed: normalized to 0 dB SPL. Unprocessed inputs: 2 V (4 ohm nominal impedance), 2.83 V (8ohm nominal impedance), or 4 V (16 ohm nominal impedance) referenced to a distance of 1 m.

2 Average angle for each 1/3 octave frequency band where, starting from the rear of the loudspeaker, the output first reaches -6 dB SPL referenced to 0 dB SPL as the highest level. This method means the output may drop below -6 dB SPL within the beamwidth angle.